

# Akuvox



## AKUVOX SP-R5xP IP Phones Administrator Guide

7/25/2014

AKUVOX NETWORK CO., LTD.

## Copyright

### **Copyright © 2014 AKUVOX NETWORK CO., LTD.**

Copyright © 2014 AKUVOX NETWORK CO., LTD.. All rights reserved. No parts of this publication may be reproduced or transmitted in any form or by any means, electronic or mechanical, photocopying, recording, or otherwise, for any purpose, without the express written permission of AKUVOX NETWORK CO., LTD. Under the law, reproducing includes translating into another language or format.

When this publication is made available on media, AKUVOX NETWORK CO., LTD. gives its consent to downloading and printing copies of the content provided in this file only for private use but not for redistribution. No parts of this publication may be subject to alteration, modification or commercial use. AKUVOX NETWORK CO., LTD. will not be liable for any damages arising from use of an illegally modified or altered publication.

## Warranty

THE SPECIFICATIONS AND INFORMATION REGARDING THE PRODUCTS IN THIS GUIDE ARE SUBJECT TO CHANGE WITHOUT NOTICE. ALL STATEMENTS, INFORMATION, AND RECOMMENDATIONS IN THIS GUIDE ARE BELIEVED TO BE ACCURATE AND PRESENTED WITHOUT WARRANTY OF ANY KIND, EXPRESS OR IMPLIED. USERS MUST TAKE FULL RESPONSIBILITY FOR THEIR APPLICATION OF PRODUCTS.

AKUVOX NETWORK CO., LTD. MAKES NO WARRANTY OF ANY KIND WITH REGARD TO THIS GUIDE, INCLUDING, BUT NOT LIMITED TO, THE IMPLIED WARRANTIES OF MERCHANTABILITY AND FITNESS FOR A PARTICULAR PURPOSE. AKUVOX NETWORK CO., LTD. shall not be liable for errors contained herein nor for incidental or consequential damages in connection with the furnishing, performance, or use of this guide.

## About This Guide

This guide is intended for administrators who need to properly configure, customize, manage, and troubleshoot the IP phone system rather than end-users. It provides details on the functionality and configuration of IP phones.

Many of the features described in this guide involve network settings, which could affect the IP phone's performance in the network. So an understanding of IP networking and a prior knowledge of IP telephony concepts are necessary.

## Documentations

This guide covers SP-R50P, SP-R52P, SP-R53P, SP-R59P IP phones. The following related documents are available:

- Quick Installation Guides, which describe how to assemble IP phones.
- Quick Reference Guides, which describe the most basic features available on IP phones.
- User Manual, which describe the basic and advanced features available on IP phones.
- Auto Provisioning Guide, which describes how to provision IP phones using the configuration files.
- <r000000000xx>.conf/<MAC>.conf template configuration files.
- Broadsoft Partner Configuration Guide, which describes how to configure BroadSoft features on the BroadWorks web portal and IP phones.

For support or service, please contact your Akuvox reseller or contact Akuvox Technical support at [techsupport@akuvox.com](mailto:techsupport@akuvox.com)

## In This Guide

The information detailed in this guide is applicable to firmware version 2 or higher. The firmware format is like xx.xx.xx.xx.rom. The third xx from left must be greater than or equal to 2 (e.g., the firmware version of SP-R53P IP phone: 53.0.2.5.rom). This administrator guide includes the following chapters:

- Chapter 1, "Product Overview" describes the SIP components and SIP IP phones.
- Chapter 2, "Getting Started" describes how to install and connect IP phones and the configuration methods.
- Chapter 3, "Configuring Basic Features" describes how to configure the basic features on

IP phones.

- Chapter 4, “Configuring Advanced Features” describes how to configure the advanced features on IP phones.
- Chapter 5, “Configuring Audio Features” describes how to configure the audio features on IP phones.
- Chapter 6, “Configuring Security Features” describes how to configure the security features on IP phones.
- Chapter 7, “Upgrading Firmware” describes how to upgrade firmware of IP phones.
- Chapter 8, “Resource Files” describes the resource files that can be downloaded by IP phones.
- Chapter 9, “Troubleshooting” describes how to troubleshoot IP phones and provides some common troubleshooting solutions.
- Chapter 10, “Appendix” reference information about IP phones and the sample configuration files.

## Table of Contents

<b>Product Overview.....</b>	<b>8</b>
VoIP Principle.....	8
SIP Components.....	9
SIP IP Phone Models.....	10
Physical Features of IP Phones.....	12
Key Features of IP Phones.....	15
<b>Getting Started.....</b>	<b>18</b>
Connecting the IP Phones.....	18
Initialization Process Overview.....	24
Verifying Startup.....	25
Reading Icons.....	27
Configuration Methods.....	27
Phone User Interface.....	28
Web User Interface.....	28
Configuration Files.....	28
Configuring Basic Network Parameters.....	29
DHCP.....	30
Configuring Network Parameters Manually.....	31
PPPoE.....	33
Transmission Methods of the Internet Port and PC Port.....	35
Configuring PC Port Mode.....	36
Upgrading Firmware.....	37
<b>Configuring Basic features.....</b>	<b>48</b>
LED Indicator.....	49
Power Indicator LED.....	49
Line Key Indicator LED.....	49
Backlight.....	50
Administrator Password.....	52
Keypad Lock.....	53
Time and Date.....	54
Language.....	60
Soft key Layout.....	61
Key as Send.....	64
Dial Plan.....	65

Replace Rule.....	65
Dial now.....	66
Area Code.....	67
Hotline.....	68
Local Phonebook.....	70
Call Log.....	72
Missed Call Log.....	73
Call Waiting.....	74
Auto Redial(aa).....	75
Auto Answer.....	76
Anonymous Call.....	77
Anonymous Call Rejection.....	78
Do Not Disturb.....	79
Return Code When Refuse.....	81
Early Media.....	81
Session Timer.....	82
Call Forward.....	83
Call Transfer.....	85
3-Way Conference.....	85
Call Pickup.....	86
Group Pickup.....	88
Call Return.....	89
Call Park.....	91
DTMF.....	92
Intercom.....	94

**Configuring Advanced Features.....97**

Distinctive ring tones.....	97
Tones.....	101
Remote Phone Book.....	103
LDAP.....	104
Busy Lamp Field.....	106
Automatic Call Distribution.....	109
Message Waiting Indicator.....	111
Call Recording.....	112
Hot Desking.....	114
Action URL.....	116
Action URI.....	119
SIP and Akuvox IP Phones.....	121
LLDP.....	126
VLAN.....	127
VPN.....	130
Quality of Service.....	131

Network Address Translation.....	133
802.1X.....	134
TR069 Device Management.....	135
<b>Configuring Audio Features.....</b>	<b>137</b>
Audio Codecs.....	137
Acoustic Clarity Technology.....	140
<b>Configuring Security Features.....</b>	<b>145</b>
Transport Layer Security.....	145
Secure Real-Time Transport Protocol.....	148
<b>Resource Files.....</b>	<b>149</b>
Local Contact File.....	150
Remote XML Phone Book.....	152
<b>Troubleshooting.....</b>	<b>154</b>
Viewing Log Files.....	154
Capturing Packets.....	156
Getting Information from Status Indicators.....	157
Analyzing Configuration File.....	157
<b>Troubleshooting Solutions.....</b>	<b>158</b>
Why is the LCD screen blank?.....	158
Why doesn't the IP phone get an IP address?.....	158
How do I find the basic information of the IP phone?.....	158
Why doesn't the IP phone upgrade firmware successfully?.....	158
Why doesn't the IP phone display time and date correctly?.....	159
Why do I get poor sound quality during a call?.....	159
What is the difference between a remote phone book and a local phone book?.....	159
What is the difference among user name, register name and display name?.....	160
How to increase or decrease the volume?.....	160
What will happen if I connect both PoE cable and power adapter? Which has the higher priority?.....	160
What is auto provisioning?.....	160
What is PnP?.....	160
Why doesn't the IP phone update the configuration?.....	161
What do "on code" and "off code" mean?.....	161
How to solve the IP conflict problem?.....	161
How to reset the IP phone to factory configurations?.....	161

---

How to restore the administrator password?.....	162
What are the main differences among SP-R50P, SP-R52P, SP-R53P, and SP-R59P?.....	162
<b>Appendix.....</b>	<b>163</b>
Appendix A: Glossary.....	163
Appendix B: Time Zones.....	165
Appendix C: Configuration Parameters.....	168
Setting Parameters in Configuration Files.....	168
Basic and advanced parameters.....	169
Appendix D: Sample Configuration File.....	188



## Product Overview

In this session, SIP IP phone models, including physical features and key features, will be described.

### SIP IP Phone Models

VoIP, voice over IP, is a methodology and group of technologies for the delivery of voice communications and multimedia sessions over Internet Protocol (IP) networks, such as the Internet. SIP, Session Initiation Protocol, is a signaling communications protocol, widely used for controlling multimedia communication sessions such as voice and video calls over Internet Protocol (IP) networks.

IP phones are the terminal devices in the overall network topology. It is designed for information workers, workers in shared workspace settings, such as front desk and call center staffs. In order to fulfill every customer's need, and it supports multi-languages with variety of calling features including call waiting, call forwarding, call transfer, call on hold, 3-way conference, direct IP call, hot desking and etc. IP phones also support advanced functionalities, including LDAP, Busy Lamp Field, and LLDP (not applicable to R50P).

The following IP phone models are described:

- SP-R50P
- SP-R52P
- SP-R53P
- SP-R59P

IP phones comply with the SIP standard (RFC 3261, RFC2543), and they can only be used within a network that supports this model of phone.

In order to successfully operate the IP phones, the following requirement must be met:

- A working IP network
- Configured routers for VoIP
- Configured VoIP Gateways for SIP
- The latest firmware running on IP phones
- An active call server

## Physical Features of IP Phones

This section lists the available physical features of IP phones.

### SP-R50P



#### Physical Features:

- DSPG Chipset
- 2.3" 132\*64 Graphical LCD with Backlight
- 31 Keys (with 4 Soft Keys 10 Programmable keys)
- RJ9 Handset Jack and Headset Jack
- 2 RJ45 10/100M Ethernet Jacks
- Wall Mount
- AC Power Adapter: Input: AC 100-240V; Output: DC 5V/1A
- PoE: IEEE 802.3af
- GiftboxSize:197\*195\*100 (mm),weight:0.8 kg

**SP-R52P****Physical Features:**

- Audiocodes Chipset
- 2.3" 132\*64 Graphical LCD with Backlight
- 34 Keys (with 4 Soft Keys)
- 4 LED Lights (1 Power Light, 2 Account Lights and 1 Voice Mail Light)
- RJ9 Handset Jack and Headset Jack
- 2 RJ45 10/100M Ethernet Jacks
- Wall Mount
- AC Power Adapter: Input: AC 100-240V; Output: DC 5V/1A
- PoE: IEEE 802.3af
- GiftboxSize:202\*239.5\*102.5 (mm),weight: 1.19 kg

**SP-R53P****Physical Features:**

- Audiocodes Chipset
- 2.9" 132\*64 Graphical LCD with Backlight
- 35 Keys (with 4 Soft Keys)
- 5 LED Lights (1 Power Light, 3 Account Lights and 1 Voice Mail Light)
- RJ9 Handset Jack and Headset Jack
- 2 RJ45 10/100M Ethernet Jacks
- Wall Mount
- AC Power Adapter: Input: AC 100-240V; Output: DC 5V/1A
- PoE: IEEE 802.3af
- GiftboxSize:202\*239.5\*102.5 (mm),weight: 1.19 kg

**SP-R59P****Physical Features:**

- Audiocodes Chipset
- 4.3" 480\*272 Graphical LCD with Backlight, 4-bit Graylevel
- 49 Keys (with 4 Soft Keys)
- 19 LED Lights (1 Power Light, 7 Account Lights, 1 Voice Mail Light and 10 extended key color indicators)
- RJ9 Handset Jack and Headset Jack
- 2 RJ45 10/100M Ethernet Jacks
- Wall Mount
- AC Power Adapter: Input: AC 100-240V; Output: DC 5V/1A
- POE: IEEE 802.3af
- RJ six expansion socket
- GiftboxSize:285.5\*224\*96.2 (mm),weight: 1.23kg

**Key Features of IP Phones**

In addition to physical features introduced above, IP phones also support the following key features when running the latest firmware:

- Phone Features

- Call Options: call waiting, call hold, call mute, call forward, call transfer, call pickup, conference.
- Basic Features: DND, keypad lock, auto redial, dial plan, hotline, auto answer.
- Advanced Features: BLF, server redundancy, distinctive ring tones, remote phone book, 802.1X authentication. (BLF and 802.1X authentication not applicable to SP-R50P IP Phone)
- Codecs and Voice Features
  - Wideband codec: G.722
  - Narrowband codec: G.723, G.726, G.729
  - VAD, CNG
  - Full-duplex speakerphone
- Network Features
  - SIP v1 (RFC2543), v2 (RFC3261)
  - NAT Traversal: STUN mode
  - DTMF: INBAND, RFC2833, SIP INFO
  - Proxy mode
  - IP assignment: Static/DHCP/PPPoE
  - VLAN assignment: LLDP/Static/DHCP
  - Bridge/Router mode for PC port (Router mode is not applicable to R50P IP Phones)
  - TFTP/FTP/HTTP/HTTPS Protocols

- HTTP/HTTPS Web Server for Management
  
- Management
  - FTP/TFTP/HTTP/HTTPS/PnP auto-provision
  
  - Configuration: browser/phone/auto-provision
  
  - Direct IP call without SIP proxy
  
  - Dial number via SIP server
  
  - Dial URL via SIP server
  
  - TR-069
  
- Security
  - HTTPS (server/client)
  
  - SRTP (RFC3711)
  
  - Transport Layer Security (TLS)
  
  - VLAN (802.1q), QoS (QoS is not applicable to SP-R50P IP Phone)
  
  - Keypad lock for personal privacy protection
  
  - Admin. configuration mode



## Getting Started

This chapter provides basic information and installation instructions of IP phones.

### Connecting the IP Phones

This section introduces items in the package, and how to install IP phones with components in packaging contents.

- Packaging Contents
- Assembling the Phone
- Startup

#### 1) Packaging Contents

The following items are included in your package. If you find anything missing, contact your system administrator.

● SP-R50P



IP Phone..



Handset..



Handset Cord..



Stand..



Ethernet Cable..



Power Adapter..



Quick Installation..  
Guide & Quick..  
Reference Guide..

● SP-R52P



IP Phone..



Handset..



Handset Cord..



Stand..



Ethernet Cable..



Power Adapter..



Quick Installation..  
Guide & Quick..  
Reference Guide..

● SP-R53P



IP Phone..



Handset..



Handset Cord..



Stand..



Ethernet Cable..



Power Adapter..



Quick Installation..  
Guide & Quick..  
Reference Guide..

● SP-R59P

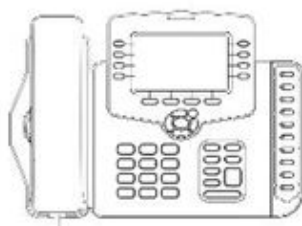

IP Phone..



Handset..



Handset Cord..



Stand..



Ethernet Cable..



Power Adapter..



Quick Installation..  
Guide & Quick..  
Reference Guide..

2) Assembling the Phone

- SP-R50P

1. Attach the stand, as shown below:

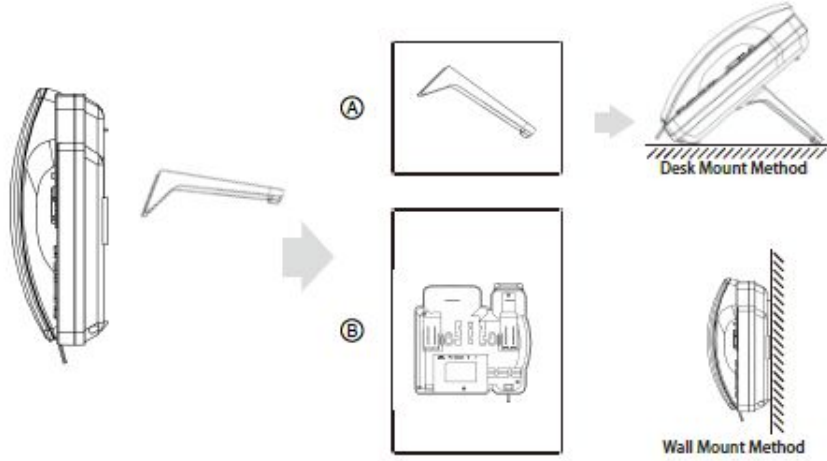

2. Connect the handset and optional headset, as shown below:

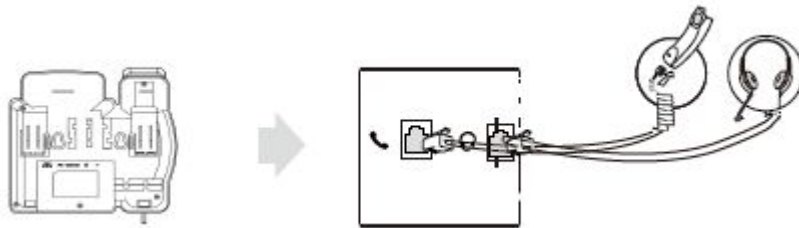

3. Connect the network and power, as shown below:

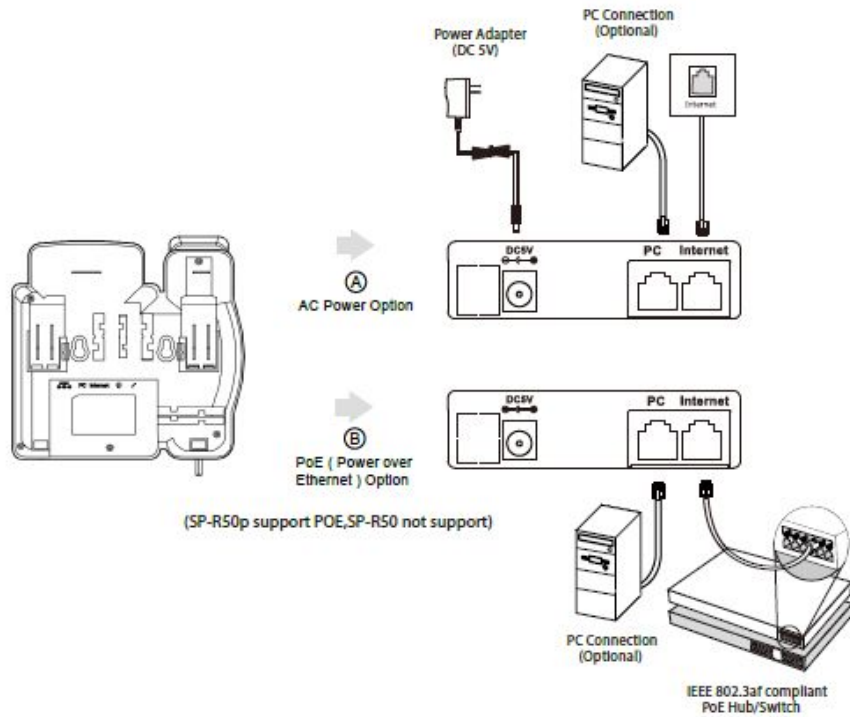

- SP-R52P

1. Attach the stand, as shown below:

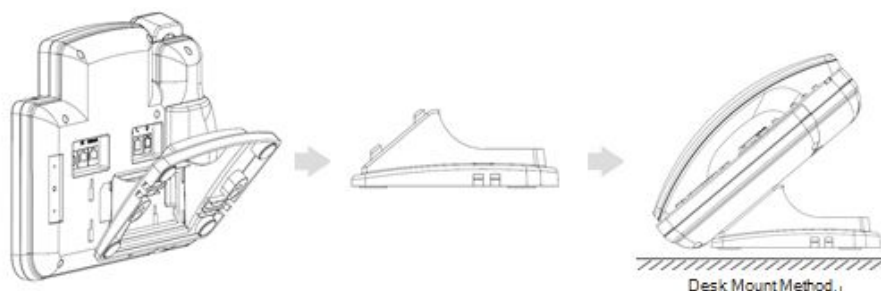

2. Connect the handset and optional headset, as shown below:

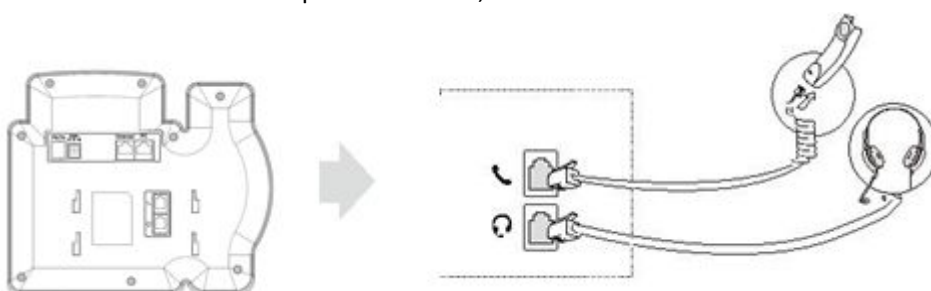

3. Connect the network and power, as shown below:

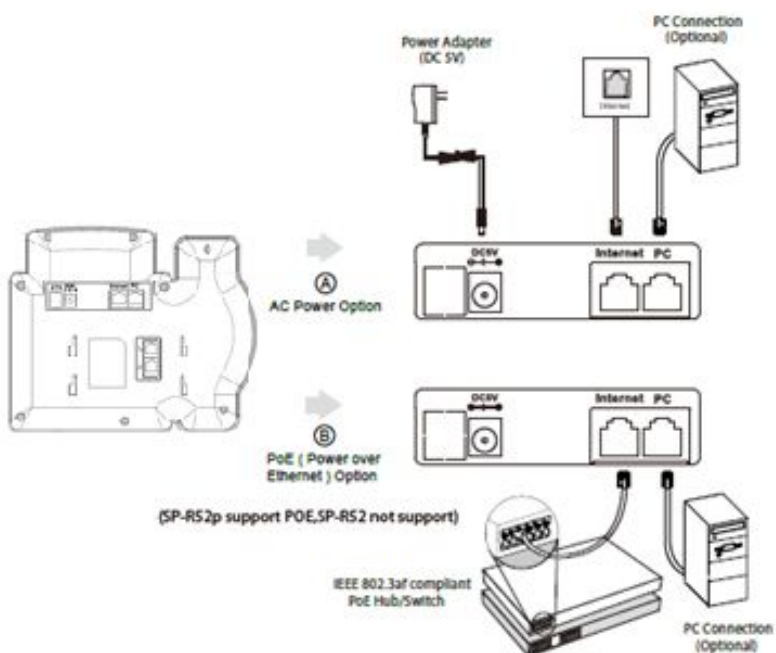

- SP-R53P

1. Attach the stand, as shown below:



2. Connect the handset and optional headset, as shown below:

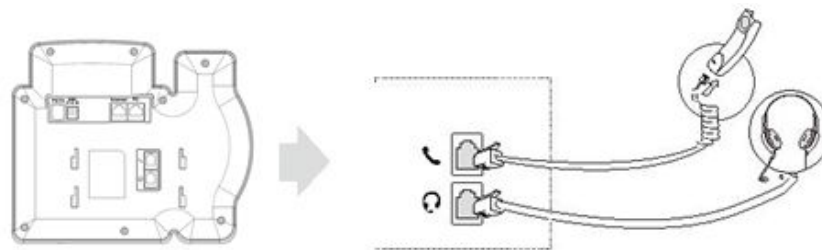

3. Connect the network and power, as shown below:

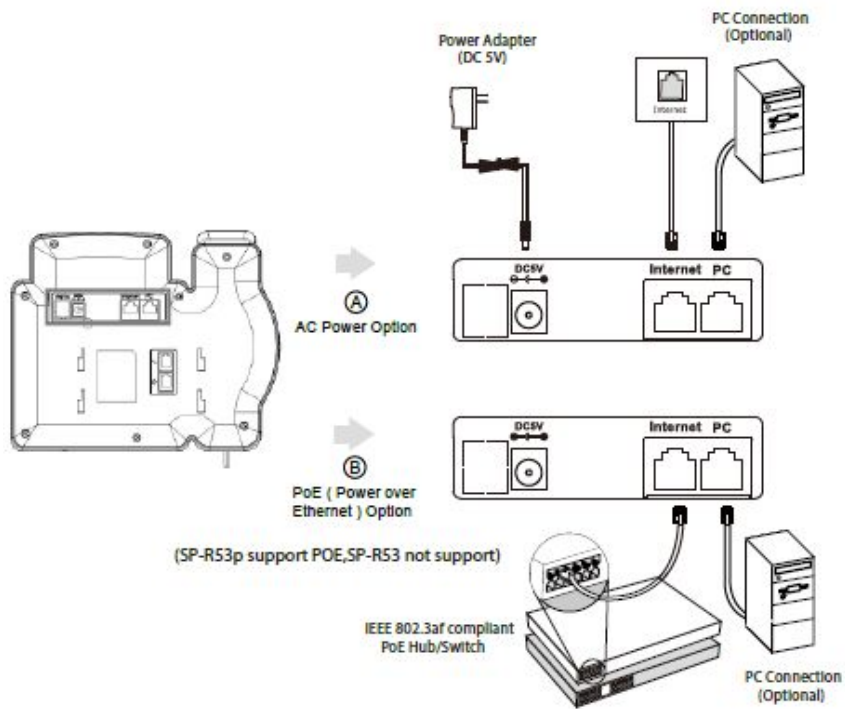

- SP-R59P

1. Attach the stand, as shown below:

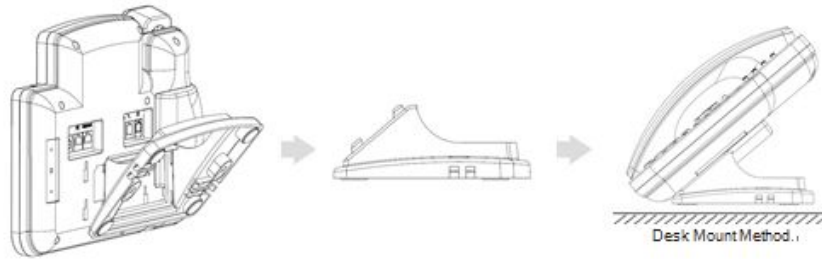

2. Connect the handset and optional headset, as shown below:

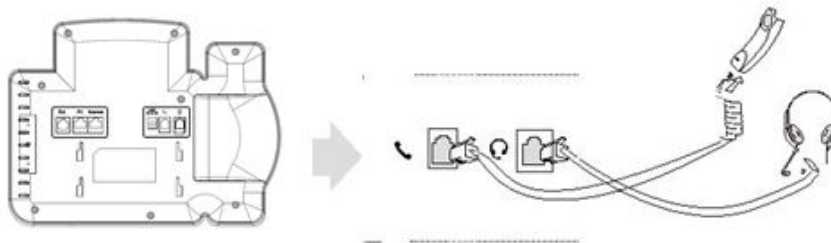

3. Connect the network and power, as shown below:

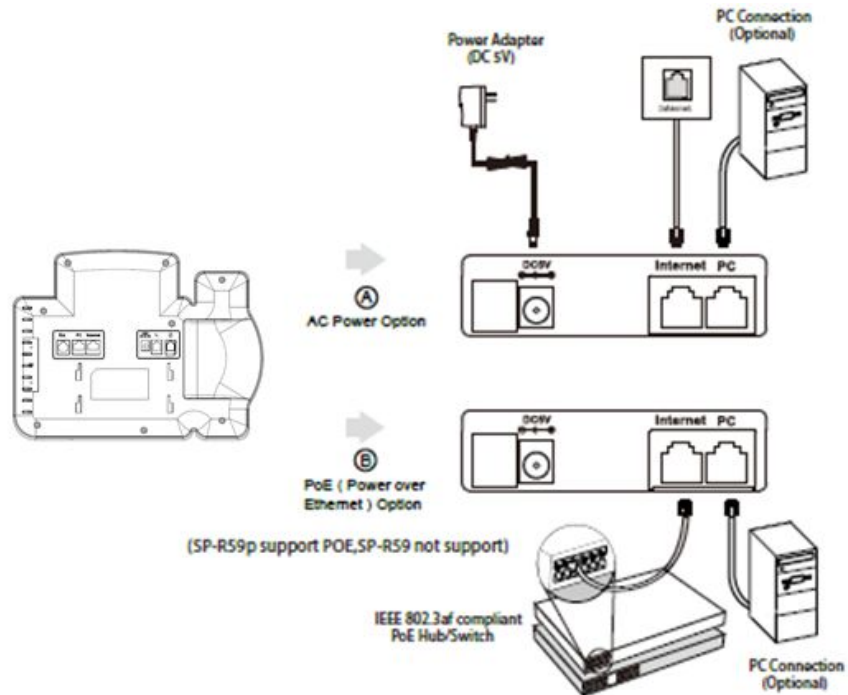

### 3) Startup

After the IP phone is connected to the network and supplied with power, it automatically begins the initialization process. After startup, the phone is ready for use. You can configure the phone via web user interface or phone user interface.

#### **Note**

No power supply is needed if in-line power switch or hub is provided

**Important!** Do not unplug or remove the power while the IP phone is updating firmware and configurations.

## **Initialization**

The IP phone will start initialization process after connecting your IP phone to the network and power supply.













During the initialization process, the IP phone will be loading the ROM file, configuring the VLAN, Querying the DHCP server, contacting the provisioning server, updating firmware, and downloading the resource files (ring tones, contact files, etc.)

#### **Note**

You need to configure network parameters of the IP phone manually if any of them is not supplied by the DHCP server.

## Reading Icons

Icons associated with different features may appear on the LCD screen. The following table provides a description for each icon on IP phones.

R50P, R52P, R53P, R59P	Description
	Register Success
	Register Failure
	Registering
	Deactivated account
	Auto Answer
	No Disturb
	Always Forward
	Network Disconnection
	Ring Off
	Headset Mode
	New Voice Message
	New Text Message
	Missed Calls

## Configuration Methods

There are three configuration methods will introduced in this session. Users can manually configure the IP phone via phone user interface and web user interface, or IP phones can be



configured automatically through configuration files.

Three configuration methods are as following.

- Phone User Interface
- Web User Interface
- Configuration Files

## Phone User Interface

An administrator or a user can configure and use IP phones via phone user interface. Access to specific features is restricted to the administrator. The default password is "admin"(case-sensitive).

## Web User Interface

An administrator or a user can configure IP phones via web user interface. The default user name and password for the administrator to log into the web user interface are both "admin" (case-sensitive). Most features are available on the web user interface. IP phones support both HTTP and HTTPS protocols for accessing the web user interface.

## Configuration Files

An administrator can deploy and maintain a mass of IP phones using configuration files.

The configuration files consist of:

- Common CONF file
- MAC-Oriented CONF file

### Common CONF file

A Common CONF file contains parameters that affect the basic and advance features. Each common CONF file is corresponding to each model with a fixed name. The name of the Common CONF file for each IP phone model is:

- SP-R50P: r000000000050.conf
- SP-R52P: r000000000052.conf
- SP-R53P: r000000000053.conf
- SP-R59P: r000000000059.conf

**MAC-Oriented CONF file**

A MAC-Oriented CONF file contains parameters unique to a particular phone. The MAC-Oriented CONF file is named after the MAC address of the IP phone. For example, if the MAC address of a SP-R52P IP phone is 0C110500184B, the name of the MAC-Oriented CONF file must be r0C110500184B.conf.

**Central Provisioning**

IP phones can be centrally provisioned from a provisioning server using the configuration files (<r0000000000xx >.conf and <MAC>.conf). IP phones support downloading configuration files using any of the following protocols: FTP, TFTP, HTTP, HTTPS and PnP.

IP phones can obtain the address of the provisioning server during startup. Then IP phones download configuration files from the provisioning server, resolve and update the configurations written in configuration files. This entire process is called auto provisioning.

**When modifying parameters, learn the following:**

- Parameters in configuration files override those stored in the IP phone's flash memory by default.
- The .conf extension of configuration files must be in lowercase.
- Each line in a configuration file must use the following format and adhere to the following rules:  
variable-name = value
  - 1) Associate only one value with one variable.
  - 2) Separate each variable name and value with an equal sign.
  - 3) Set only one variable per line.
  - 4) Put the variable and value on the same line, and do not break the line.
  - 5) Comment the variable on a separated line. Use the pound (#) delimiter to distinguish the comments.

## Configuring Basic Network Parameters

In order to get your IP phones running, you must perform basic network setup, such as IP address and subnet mask configuration. This section describes how to configure basic network parameters for IP phones.

## DHCP

DHCP, standstill for Dynamic Host Configuration Protocol, is a standardized networking protocol used on Internet Protocol (IP) networks for dynamically distributing network configuration parameters, such as IP addresses for interfaces and services. With DHCP, IP phones request IP addresses and networking parameters automatically from a DHCP server, reducing the need for a network administrator or a user to configure these settings manually.

### Procedure

DHCP can be configured using the configuration files or locally

<b>Configuration File</b>	<r0000000000xx>.conf/<MAC>.conf	Configure DHCP on the IP phone. Configure static DNS address when DHCP is sued.
<b>Local</b>	Web User Interface	Configure DHCP on the IP phone. Configure static DNS address when DHCP is sued. Navigate to: <a href="http://&lt;phoneIPAddress&gt;/fcgi/do?id=2&amp;id=1">http://&lt;phoneIPAddress&gt;/fcgi/do?id=2&amp;id=1</a>
	Phone User Interface	Configure DHCP on the IP phone.

### To configure DHCP via web user interface:

1. Click on **Network > Basic**
2. In **LAN Port**, mark the **DHCP** radio box.

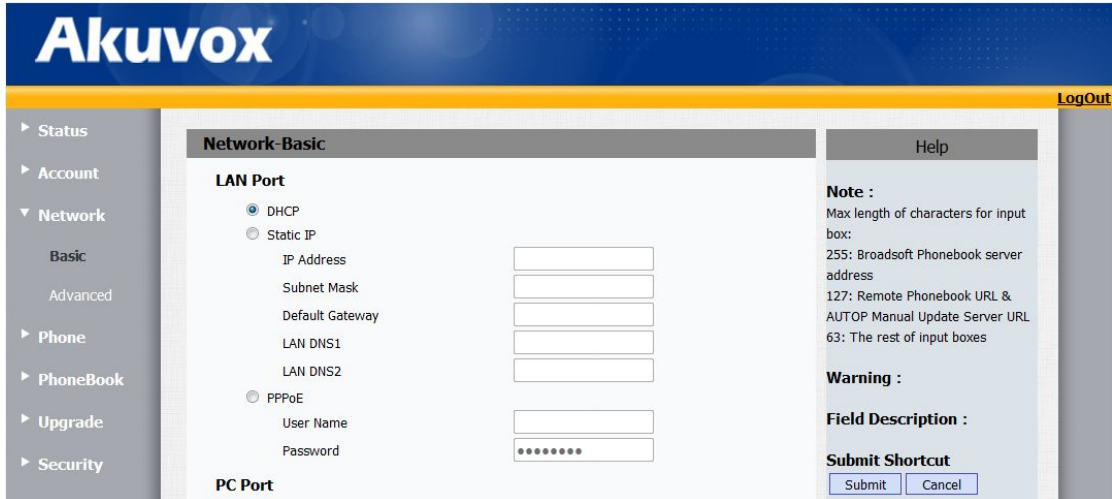

3. Click **Submit** to accept the change.

A dialog box pops up to prompt that if the IP has been changed, please login again.

4. Click **OK** to confirm and login again

**To configure DHCP via phone user interface:**

1. Press **Menu > Settings > Advanced Setting (password: admin) > Network > LAN Port.**
2. Press **Up** or **Down** button to highlight the DHCP
3. Press **Enter** to accept the change

The IP phone makes settings effective after a short period of time.

## Static IP

When static IP is applied, it means you need to configure the network parameter manually.

The following parameters should be configured for IP phones to establish network connectivity:

- IP Address
- Subnet Mask
- Gateway
- Primary DNS
- Secondary DNS

**Procedure**

Network parameters can be configured manually using the configuration files or locally.

<b>Configuration File</b>	<code>&lt;r0000000000xx&gt;.conf/&lt;MAC&gt;.conf</code>	Configure network parameters of the IP phone manually
---------------------------	--	---

<b>Local</b>	Web User Interface	Configure network parameters of the IP phone manually Navigate to: <a href="http://&lt;phoneIPAddress&gt;/fcgi/do?id=2&amp;id=1">http://&lt;phoneIPAddress&gt;/fcgi/do?id=2&amp;id=1</a>
	Phone User Interface	Configure network parameters of the IP phone manually

**To configure the IP address mode via web user interface**

1. Click on **Network > Basic**
2. In **LAN Port**, mark the **Static IP** radio box.
3. Enter the desired values in the **IP address, Subnet Mask, Default Gateway, LAN DNS1** and **LAN DNS 2** fields

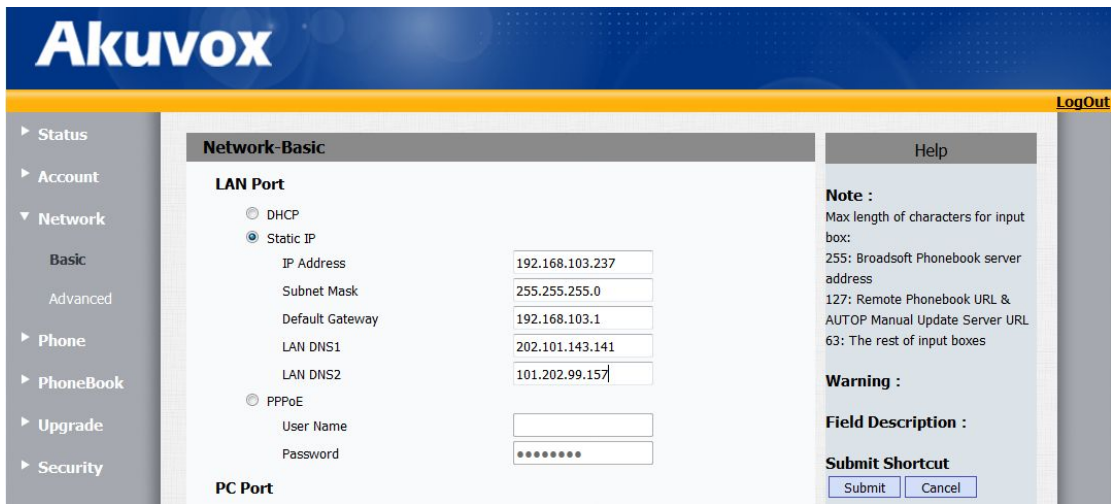

4. Click **Submit** to accept the change  
A dialog box pops up to prompt that if the IP has been changed, please login again.
5. Click **OK** to login again

**To configure the IP address mode via phone user interface:**

1. Press **Menu > Settings > Advanced Settings (password: admin) > Network > LAN Port**
2. Press **Up** or **Down** buttons to highlight **Static IP**
3. Press **Enter** to enter the **Static IP settings**
4. Enter the desired values in the **IP address, Subnet Mask, Gateway, DNS1** and **DNS2** fields.
5. Press the **Save** to accept the change  
The IP phone makes settings effective after a short period of time.

**Note**

Using the wrong network parameters may result in inaccessibility of your phone and may

also have an impact on your network performance. For more information on these parameters, contact your network administrator.

## PPPoE

PPPoE is Point-to-Point Protocol over Ethernet. It is a network protocol for encapsulating PPP frames inside Ethernet frames. It is a network protocol used by Internet Service Providers (ISPs) to provide Digital Subscriber Line (DSL) high speed Internet services.

### Procedure

PPPoE can be configured using the configuration files or locally.

<b>Configuration File</b>	<r0000000000xx>.conf/<MAC>.conf	Configure PPPoE on the IP phone.
<b>Local</b>	Web User Interface	Configure PPPoE on the IP phone. Navigate to: http://<phoneIPAddress>/fcgi/do?id=2&id=1
	Phone User Interface	Configure PPPoE on the IP phone.

#### To configure PPPoE via web user interface

1. Click on **Network > Basic**
2. In **LAN Port**, mark the **PPPoE** radio box.
3. Enter the user name and password in corresponding fields.

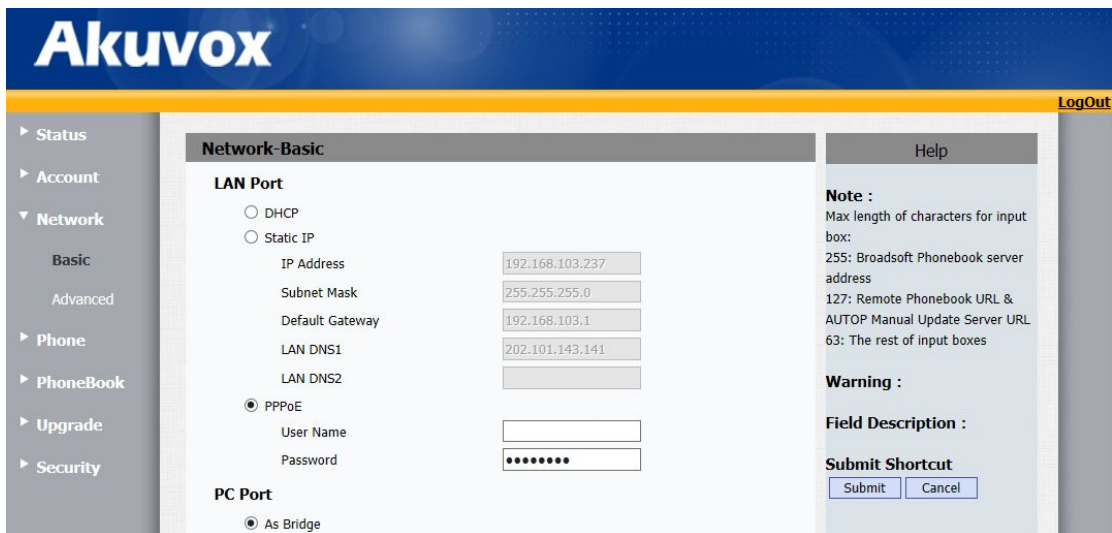

4. Click **Submit** to accept the change

A dialog box pops up to prompt that if the IP has been changed, please login again.

5. Click **OK** to login again

**To configure PPPoE via phone user interface:**

1. Press **Menu** > **Settings** > **Advanced Setting (password: admin)** > **Network** > **LAN Port**.
2. Press **Up** or **Down** buttons to highlight PPPoE
3. Press **Enter** to enter the PPPoE setting
4. Enter the user name and password in corresponding fields
5. Press **Save** to accept the change

The IP phone makes settings effective after a short period of time.

## Transmission Methods of the Internet Port and PC Port

The transmission method configured for IP phone Internet and PC ports are Auto-negotiation by default.

### Auto-negotiation

Auto-negotiation is an Ethernet procedure by which two connected devices choose common transmission parameters, such as speed, duplex mode, and flow control. In this process, the connected devices first share their capabilities regarding these parameters and then choose the highest performance transmission mode they both support.

### Full-duplex

Full-duplex transmission refers to transmitting voice or data in both directions at the same time; this means one device can send data on the line while receiving data. You can configure the full-duplex transmission on both Internet port and PC port for the IP phone to transmit in 10Mbps or 100Mbps.

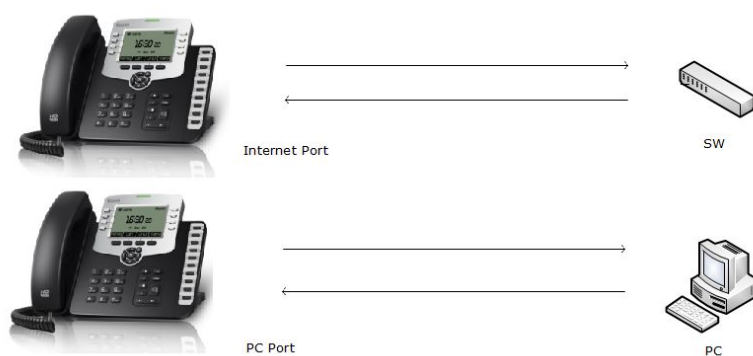



## Configuring PC Port Mode

The PC port on the back of the IP phone is used to connect a PC, which can be configured in one of two modes:

- **Bridge:** The IP phone functions as a bridge, and the connected PC appears on the network as a stand-alone device with its own IP address.
- **Router:** The IP phone functions as a router, and provides a DHCP service for the connected PC.

If the PC port is unused, it can be disabled via web user interface or using configuration files.

### Note

The Router mode is **NOT** applicable to SP-R50P phone.

### Procedure

Pc port mode can be configured using the configuration files or locally

<b>Configuration File</b>	<r0000000000xx>.conf/<MAC>.conf	Configure the PC port mode.
<b>Local</b>	Web User Interface	Configure the PC port mode. Navigate to: <a href="http://&lt;phoneIPAddress&gt;/fcgi/do?id=2&amp;id=1">http://&lt;phoneIPAddress&gt;/fcgi/do?id=2&amp;id=1</a>
	Phone User Interface	Configure the PC port mode.

### To configure the PC port mode via web user interface:

1. Click on **Network > PC Port**
2. Mark the desired radio box

If the **As Router** radio box is marked, you can configure the IP address for the PC port and configure DHCP for the PC attached to the PC port.

- 1) Enter the IP address in the **IP Address** field.
- 2) Enter subnet mask in the **Subnet Mask** field.
- 3) Select the desired value from the pull-down list of Enable **DHCP Server**.
- 4) Enter the start IP address in the **Start IP Address** field.
- 5) Enter the end IP address in the **End IP Address** field.

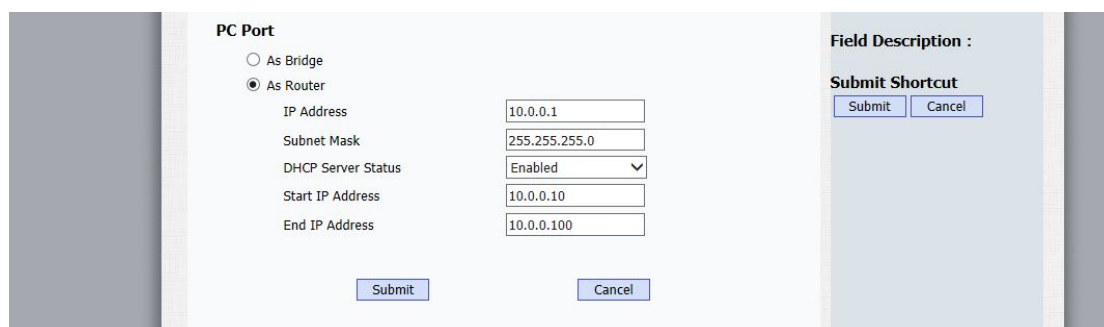

3. Click **Submit** to accept the change

A dialog box pops up to prompt that router setting: required to reboot to make changings take effect, are you sure to reboot

4. Click **OK** to reboot the IP phone

#### To configure the PC port mode via phone user interface:

1. Press **Menu > Settings > Advanced Setting** (password: admin) > **Network > PC Port**

2. Select the desired mode.

If you select Router, you can configure the IP address for the PC port and configure DHCP for the PC attached to the PC port.

- 1) Enter the IP address in **IP Address** field.
- 2) Enter the subnet mask in the **Subnet Mask** field.
- 3) Press **Left** or **Right** to enable DHCP Server.
- 4) Enter the start IP address in the **Start IP** field.
- 5) Enter the end IP address in the **End IP** field.

3. Press **Save** to accept the change

A dialog box pops up to prompt that phone restart, please wait. Settings will take effect after a reboot

## Upgrading Firmware

This section provides information on upgrading the IP phone firmware. Two methods of firmware upgrade:

- Manually, from the local system for a single phone.
- Automatically, from the provisioning server for a mass of phones.

The following table lists the associated and latest firmware name for each IP phone model (X is replaced by the actual firmware version).

IP Phone Model	Associated Firmware Name	Firmware Name Example
SP-R50P	50.x.x.x.rom	50.0.1.10.rom
SP-R52P	52.x.x.x.rom	52.0.1.11.rom
SP-R53P	53.x.x.x.rom	53.0.1.12.rom
SP-R59P	59.x.x.x.rom	59.0.1.13.rom

### Note

You can download the latest firmware online: <http://www.akuvox.com/en/download/>

Do not unplug the network and power cables when the IP phones are upgrading firmware.

### Upgrade via Web User Interface

To manually upgrade firmware via web user interface, you need to store firmware to your local system in advance.

#### To upgrade firmware manually via web user interface:

1. Click on **Upgrade > Basic**
2. Click **Browse**
3. Select the desired firmware from the local system

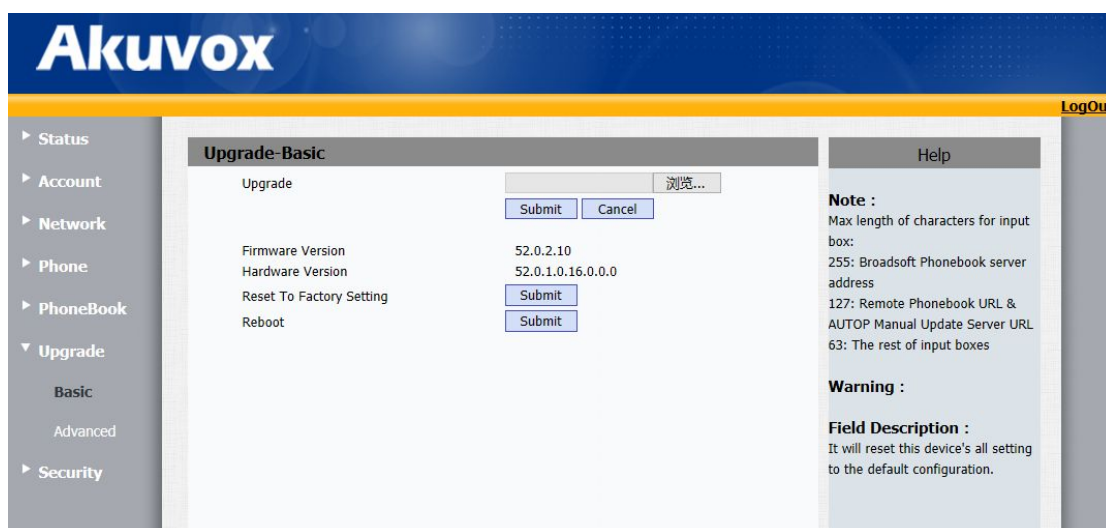

4. Click **Submit**

A dialog box pops up to prompt "Do you want to upgrade? Make sure the rom file is OK!"

5. Click **OK** to confirm the upgrade

**Note**

Do not close and refresh the browser when the IP phone is upgrading firmware via web user interface.

**Upgrade Firmware from the Provisioning Server**

IP Phones use DHCP/PNP/TFTP/FTP/HTTP/HTTPS network protocols to get URL, and then download firmware and/or its corresponding configuration files from that server. These configuration files and firmware will be used to update firmware and the corresponding parameters on the phone.

IP Phones can be configured to resynchronize its internal configuration state to match a remote profile periodically and on power up by contacting a normal provisioning server (NPS) or an access control server (ACS). In this document, we assume that the administrator knows how to set up the NPS and ACS (DHCP, PNP, TFTP, FTP, HTTP, and HTTPS servers).

By default, a profile resync is only attempted when IP Phones are idle, because the upgrade might trigger a software reboot interrupting a call.

**Automatic deployment has the following features**

- General configuration provisioning: In this scenario, a general configuration file is stored in the server and all IP Phones download the same configuration file to update their parameters.
- MAC based configuration provisioning: In this scenario, each configuration file is for a specific IP Phone with the MAC address that matches the file name. The parameters in this configuration file are for that specific IP Phone only. This is normally for the account related parameters.

**Procedure**

Configuration changes can be performed using the configuration files or locally

<b>Configuration File</b>	<r000000000xx>.conf/<MAC>.conf	Configure the way for the IP phone to check for configuration files.
<b>Local</b>	Web User Interface	Configure the way for the IP phone to check for configuration files. Navigate to: <a href="http://&lt;phoneIPAddress&gt;/fcgi/do?id=6&amp;id=2">http://&lt;phoneIPAddress&gt;/fcgi/do?id=6&amp;id=2</a>

Phone User Interface

Configure the way for the IP phone to check for configuration files.

**Working Principle and Functions**

A complete automatic upgrade process consists of the following:

1. Administrator sets up the NPS and ACS servers with the required information.
2. IP phone gets the URL of the configuration file server
3. IP phone download the configuration file from the configuration server with URL obtained in step 2.
4. The configuration parameters in the configuration file are written to the appropriate configuration files in the IP phone
5. If configuration file contains the content for upgrading the firmware, IP phone will get the firmware and do a firmware update.

**Obtaining the update server URL**

When an IP Phone power on, it will try to obtain the upgrade server address in the following order: PnP Server -> User Specified Server -> Dhcp Custom Option-> Dhcp Option66-> Dhcp Option43. You can use any one of the above methods to setup the auto provisioning.

To set up the auto provisioning, use the web interface on the IP Phone. The following is a detailed description of the process. The auto provisioning setup is under "Upgrade -> Advanced" on the IP Phone web page.

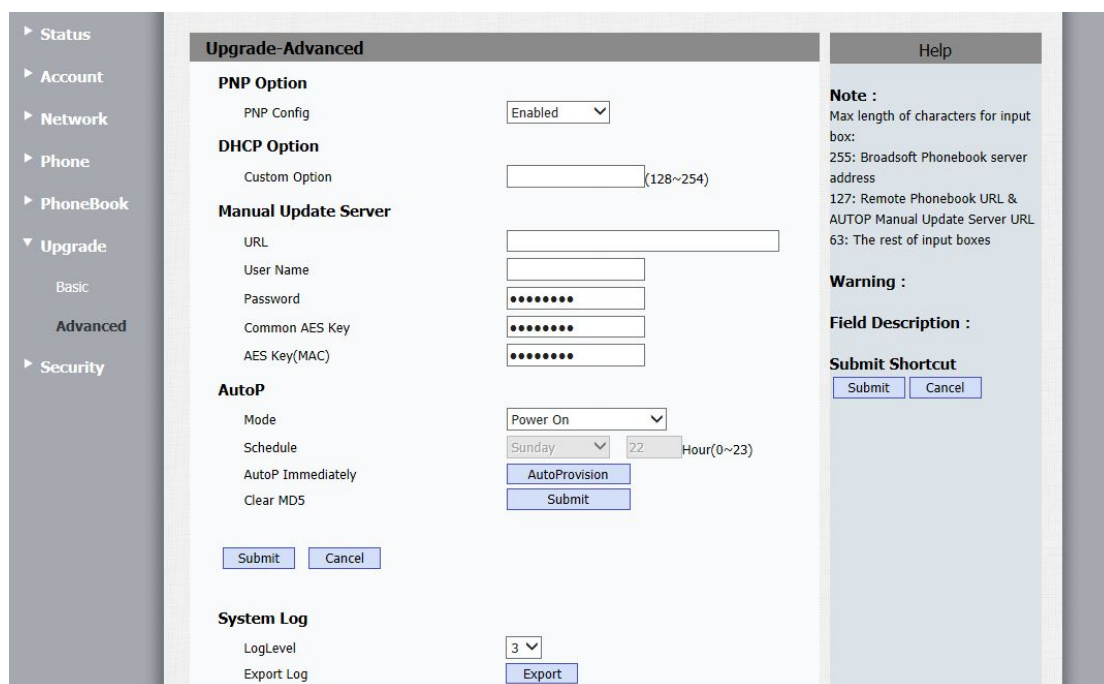

### 1. PNP:

PNP stands for Plug and Play (Plug and Play). PNP provides a proprietary automatic upgrade, when PNP upgrade mode is enabled, the phone will broadcast a "SIP SUBSCRIBE" in the network. A SIP server will reply with a "SIP NOTIFY" with the URL of the firmware and/or configuration file server.

The following procedure is for setting up PNP auto provisioning:

- First, you need to configure the SIP server to have PNP and set the update server URL in it.
- Set PNP Config to Enable and click the [AutoProvision] button. The phone will use PNP to get the correct auto provisioning URL and download the firmware and the configuration files;
- If autop mode is set, the phone will do the auto provisioning on the specified time frame as set in the autop mode.

### 2. User-Specified Server:

Users can manually set a specific server URL for downloading the firmware and/or configuration file.

The procedure with following TFTP example:

- Set Manual Update Server URL to TFTP Server (e.g., "tftp://192.168.10.135"), click

[AutoProvision], the phone will use the URL to download the appropriate firmware and/or configuration file from the TFTP server and upgrade the phone using the downloaded file;

- If autop mode is set, the phone will do the auto provisioning on the specified time frame as set in the autop mode.

**Upgrade-Advanced**

**PNP Option**

PNP Config Disabled

**DHCP Option**

Custom Option  (128~254)

**Manual Update Server**

URL

User Name

Password

Common AES Key

AES Key(MAC)

**AutoP**

Mode Power On

Schedule Sunday  22 Hour(0~23)

AutoP Immediately

Clear MD5

**System Log**

LogLevel 7

Export Log

**PCAP**

PCAP

We can also use FTP, HTTP, or HTTPS as the protocol for upgrading the phone firmware and/or configuration. The formats of them are as follows:

A. TFTP Format:

tftp:/ /192.168.0.19/

B. FTP Format:

ftp://192.168.0.19/ (allows anonymous login)

ftp://username:password@192.168.0.19/ (requires a user name and password)

C. HTTP Format:

http://192.168.0.19/ (use the default port 80)

http://192.168.0.19:8080/ (use other ports, such as 8080)

D. HTTPS Format:

https://192.168.0.19/ (use the default port 443)

3. DHCP Custom Option:

If the phone is set to use DHCP Option to obtain the auto provisioning URL, the phone will send a request to a DHCP server for a specific DHCP option code. To use DHCP Custom Option (user-defined, the range of option code is from 128 to 255), you must first configure the DHCP Custom Option on the web page

DHCP Option Configuration (Example uses 230 as the custom DHCP option code. You can use any custom DHCP option code from 128 to 255):

- First, you need to configure DHCP server to have a specific custom option code 230 with the update server URL in it.
- Set Custom Option to 230. Click [AutoProvision], the phone will get the upgrade server URL from the DHCP server with the option code 230.
- If autop mode is set, the phone will do the auto provisioning on the specified time frame as set in the autop mode.



Upgrade-Advanced

**PNP Option**

PNP Config Disabled

**DHCP Option**

Custom Option  (128~254)

**Manual Update Server**

URL

User Name

Password

Common AES Key

AES Key(MAC)

**AutoP**

Mode Power On

Schedule Sunday  22 Hour(0~23)

AutoP Immediately

Clear MD5

**System Log**

LogLevel 7

Export Log

**PCAP**

PCAP

4. DHCP Option 66

If none of the above is set, the phone will automatically use DHCP Option 66 for getting the upgrade server URL. This is done within the software and the user does not need to specify this. For this to work, you need to configure the DHCP server for the option 66 with the update server URL in it.

5. DHCP Option 43

If the phone does not get an URL from DHCP Option 66, it will automatically use DHCP Option 43. This is done within the software and the user does not need to specify this. For this to work, you need to configure the DHCP server for the option 43 with the update server URL in it.

**AUTOP modes:**

The phone supports the following three modes:

- A. Disable: Disables autop. The phone will not check for any updates and will not

- upgrade the phone automatically;
- B. Power on: The phone does the autop when the IP phone power is turned on;
- C. Periodical: The phone does the autop at specified time frame periodically;

### Downloading Configuration File

There are two types of configuration files for download:

- General configuration file: This configuration file has common configuration parameters for all IP Phones.
- MAC based configuration file: This configuration file is for use by a specific IP Phone with the specified MAC address. It is normally related to account information.

If you have both of these files on the server, IP Phone will first get the General configuration file first and then get the MAC based configuration file using its MAC address as the ID.

### Configuration Parameter Description and Application

Update configuration parameters

The parameters that will be updated should follow the following format in the configuration file, as shown below.

```

38 #####
39 ###                               Network Configuration                               ###
40 #####
41
42 #Configure the LAN port type; 0:DHCP(default); 1:PPPoE; 2:Static IP;
43 Config.Network.Lan.Type = 0
44
45 #Configure the Static IP address,mask,gateway and DNS server;
46 Config.Network.Lan.Ip =
47 Config.Network.Lan.Mask =
48 Config.Network.Lan.Gateway =
49 Config.Network.Lan.PrimaryDNS =
50 Config.Network.Lan.SecondaryDNS =
51
52 #Configure the username and password for PPPoE connection;
53 Config.Network.Pppoe.Username =
54 Config.Network.Pppoe.Password =
55
56 #Enable or disable the LAN port VLAN; 0:Disabled(default); 1:Enabled;
57 Config.Network.Vlan.LanVlanEnable = 0
58
59 #Configure the LAN port VLAN ID, ranges from 0 to 4094, (0 by default);
60 Config.Network.Vlan.LanVid = 0
61
62 #Configure the LAN port VLAN priority, ranges from 0 to 7,(0 by default);
63 Config.Network.Vlan.LanPriority = 0
64
65 #Enable or disable the SNMP feature; 0:Disabled(default); 1:Enabled
66 Config.Network.Snmp.Enable = 0
67
68 #Configure the SNMP port
69 Config.Network.Snmp.Port =
70
71 #Configure the IP address of the SNMP server
72 Config.Network.Snmp.TrustedIP =
73

```

The name of the parameters in the configuration file is fixed, and the user can not

make any changes, the user can only fill in the value, otherwise the update will fail.

Example: To set the PPPOE username and password info, you use the following format:

```
#Configure the username and password for PPPOE connection;  
Config.Network.Pppoe.Username = james  
Config.Network.Pppoe.Password = 123456
```

Note: Each line in the configuration file beginning with # is a comment statement does not affect the update.

Once the configuration file is updated successfully with the configuration file shown above, the user will login to the pppoe server by username(James) and password(123456).

### **Firmware and/or Configuration File Updates**

The followings are some of the common file updates.

#### 1. Firmware Update

To update firmware, you define the following lines in the configuration file:

```
Config.Firmware.Url = protocol name://address/path/filename
```

Example:

```
Config.Firmware.Url = tftp://192.168.10.19/1.0.0.135.rom
```

#### 2. Personalized Ringtones

To set personalized ringtones, you define the following lines in the configuration file:

```
Config.Ringtone.Url = protocol name://address/path/filename
```

Example:

```
Config.Ringtone.Url = tftp://192.168.10.19/Ring1.wav
```

Note: Ring1.wav is a ringtone wav file. Total custom ringtone file size cannot be more than 100KB.

To update two custom ringtones, you define the following lines in the configuration file:

Config.Ringtone.Url = tftp://192.168.10.19/Ring1.wav

Config.Ringtone.Url = tftp://192.168.10.19/Ring2.wav

### 3. Update Local Contacts

To update local contacts, you define the following lines in the configuration file:

Config.Contact.Url = protocol name://address/path/filename

Example:

Config.Contact.Url = tftp://192.168.10.19/Contact.xml

Note: Contact.xml is the file name for the address book.

## Configuring Basic features

This chapter provides information for making configuration changes for the following basic features:

### Power Indicator LED

LED Status	Description
Emerald	The phone is initializing. The phone is idle.
Off	The phone is powered off.

### Line Key Indicator LED

Line key LED indicates account and phone status. It is set by default (Line key indicator LED is not applicable to R50P IP Phones).

#### Line Key Indicator LED

LED Status	Description
Fast flashing emerald (800ms)	The line receives an incoming call.
Slow flashing emerald (2000ms)	The call is placed on hold or is held.
Emerald	The line is in conversation. The line is dialing. The call is mute.
Off	The line is inactive.

#### Note

Power indicator LED and line key indicator LED features are only applicable to IP phones running the latest firmware version. For more indicator status, please refer to [Busy Lamp Field](#).

### Message LED

LED Status	Description
------------	-------------

Emerald	The phone receives voice mail.
Off	The phone is no voice mail.

**Note**

Message indicator LED is not applicable to R50P IP Phones)

## Line key LED (configured as a BLF key)

LED Status	Description
Emerald	The monitored user is idle.
Fast flashing emerald (800ms)	The monitored user receives an incoming call. The monitored user is dialing.
Slow flashing emerald (2000ms)	The monitored user's conversation is placed on hold or is held. The monitored user is in conversation. The call is mute the monitored user's phone number.
Off	The monitored user does not exist.

## DSS Key (Configured as a BLF key)

LED Status	Description
Emerald	The monitored user is idle.
Slow flashing Red	The monitored user receives an incoming call. The monitored user is dialing. The monitored user is in conversation. The monitored user's conversation is placed on hold or is held.
Off	The monitored user does not exist.

**Note**

DSS Key indicator LED is only applicable to R59P IP Phones)

## Backlight

Backlight allows users to read in darkness easily, and it determines the brightness of the LCD screen display. Backlight time specifies the delay time to turn off the backlight when the IP phone is inactive. The time for backlight to turn off can be configured. One could set up the desired turn off time to have enough time to read the messages. Backlight intensity level is used to adjust the backlight intensity of the LCD screen.

You can configure the backlight time as one of the following types:

- **Always Off:** Backlight is turned off permanently.
- **Always On:** Backlight is turned on permanently.
- 10, 20, 30, 40, 50, 60, 90 or 120: Backlight is turned off when the IP phone is inactive after a preset period of time (in seconds), but it is automatically turned on if the status of the IP phone changes or any key is pressed.

### Procedure

Backlight can be configured using the configuration files or locally.

<b>Configuration File</b>	<r0000000000xx>.conf/<MAC>.conf	Backlight Intensity Level Backlight Time
<b>Local</b>	Web User Interface	Backlight Intensity Level Backlight Time Navigate to: <a href="http://&lt;phoneIPAddress&gt;/fcgi/do?id=4&amp;id=4">http://&lt;phoneIPAddress&gt;/fcgi/do?id=4&amp;id=4</a>
	Phone User Interface	Backlight Intensity Level Backlight Time

### To configure backlight via web user interface:

1. Click on **Phone > Key/Display**
2. Select the desired value from the pull-down list of **Backlight Intensity Level**
3. Select the desired value from the pull-down list of **Backlight Time** (seconds)

**Key/Display**

**Line Key**

Key	Type	Label	Value	Extension	Account
Line Key 1	Account				Account 1
Line Key 2	Account				Account 2
Line Key 3	Account				Account 3

**Soft Key**

Key	Type	Label	Value	Account
Soft Key 1	History			Auto
Soft Key 2	Book			Auto
Soft Key 3	DND			Auto
Soft Key 4	Menu			Auto

**Function Key**

Key	Type	Value	Account
OK	Status		Auto
Cancel	N/A		Auto
Forward	Fwd		Auto
Book	Book		Auto
RD	Redial		Auto
Mute	N/A		Auto

**Others**

Backlight Intensity: 4

Backlight Time: 20

**Help**

**Note :**  
Max length of characters for input box:  
255: Broadsoft Phonebook server address  
127: Remote Phonebook URL & AUTOP Manual Update Server URL  
63: The rest of input boxes

**Warning :**

**Field Description :**

**Submit Shortcut**  
Submit Cancel

Submit Cancel

4. Click **Submit** to accept the change

#### To configure backlight via phone user interface

1. Press **Menu > Settings > Basic Setting**
2. Press **Up** or **Down** to highlight **Backlight**
3. Press **Enter** to enter **Backlight Setting**
4. Press **Up** or **Down** to select **Level** or **Time**
5. Press **Left** or **Right** to set the values
6. Press **Save** to accept the change



## Administrator Password

Administrator password is strictly for system administrator use. The administrator password can only be changed by an administrator. The default administrator password is “admin”. For security reasons, the administrator password should be changed as soon as possible.

### Procedure

Administrator password can be change using the configuration files or locally.

<b>Configuration File</b>	<r0000000000xx>.conf/<MAC>.conf	Change the administrator password
<b>Local</b>	Web User Interface	Change the administrator password Navigate to: http://<phoneIPAddress>/fcgi/do?id=7&id=1
	Phone User Interface	Change the administrator password

### To change the administrator password via web user interface:

1. Click on **Security > Basic**
2. Enter the current password in **Current Password** field
3. Enter the new password in **New Password** field
4. Enter your new password again in **Confirm Password** field

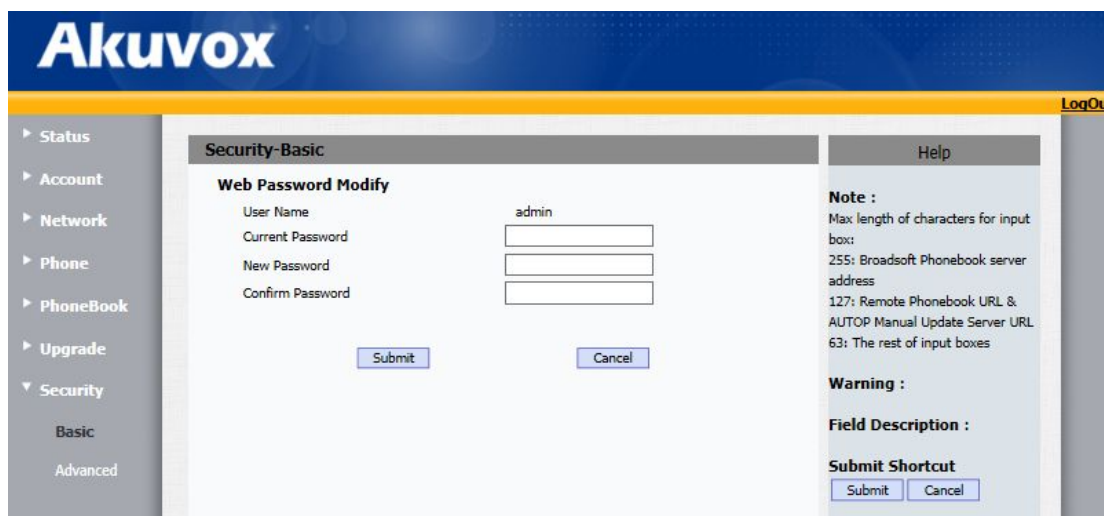

5. Click **Submit** to accept the change.

**To change the administrator password via phone user interface:**

1. Press **Menu > Settings > Advanced Setting** (password: admin).
2. Press **Up** or **Down** to highlight **Password Setting**
3. Enter current password in the **Current Password** field
4. Enter the new password in **New Password** field
5. Enter your new password again in **Confirm Password** field.
6. Press **Save** to accept the change

## Keypad Lock

To prevent from unauthorized use, Keypad lock allows users to lock the IP phone. When the IP phone is locked, one cannot have the access to the Once the IP phone without the correct password. IP phones offer two types of phone lock: Function Keys and All Keys. The IP phone will not be locked immediately after the phone lock type is configured.

**Procedure**

Keypad lock can be configured using the configuration files or locally.

<b>Configuration File</b>	<r0000000000xx>.conf/<MAC>.conf	Configure type of keypad lock. Change the unlock PIN. Configure the IP phone to automatically lock the keypad after a time interval
<b>Local</b>	Web User Interface	Configure type of keypad lock. Change the unlock PIN. Configure the IP phone to automatically lock the keypad after a time interval Navigate to: <a href="http://&lt;phoneIPAddress&gt;/fcgi/do?id=4&amp;id=2">http://&lt;phoneIPAddress&gt;/fcgi/do?id=4&amp;id=2</a>

**To configure phone lock via web user interface:**

1. Click on **Phone > Call Feature**
2. Select the desired type from the pull-down list of **Keypad Lock Type**
3. Enter the unlock PIN in the **Keypad Unlock PIN (0~15 Digit)** field
4. Enter the desired time in the **Keypad Lock Timeout** field

**Keypad Lock**

Keypad Lock Type All Keys

Keypad Unlock PIN ●●●●●● (0~15)

Keypad Lock Timeout 30 (0~3600s)

5. Click **Submit** to accept the change.

## Time and Date

Time and date that are synced automatically from the NTP server by default are displayed on the idle screen of IP phones. The NTP server can be obtained by DHCP or configured manually. If IP phones cannot obtain the time and date from the NTP server, you need to manually configure them. The time and date display can use one of several different formats.

### Time Zone

A time zone is a region on Earth that has a uniform standard time. It is convenient for areas in close commercial or other communication to keep the same time. When configuring the IP phone to obtain the time and date from the NTP server, you must set the time zone.

### Daylight Saving Time

Daylight Saving Time (DST) is the practice of temporary advancing clocks during the summertime so that evenings have more daylight and mornings have less. Typically, clocks are adjusted forward one hour at the start of spring and backward in autumn.

The following table lists available configuration methods for time and date.

Option	Configuration methods
Time Zone	Configuration Files Web User Interface Phone User interface
Time	Web User Interface Phone User Interface
Time Format	Configuration Files Web User Interface Phone User interface

Date	Web User Interface Phone User Interface
Date Format	Configuration Files Web User Interface Phone User interface
Daylight Saving Time	Configuration Files Web User Interface Phone User interface

**Procedure**

Configuration changes can be performed using the configuration files or locally.

<b>Configuration File</b>	<r0000000000xx>.conf/<MAC>.conf	Configure the NTP Primary server, Secondary server, time zone and Upgrade interval. Configure the time and date manually. Configure the time and date formats. Configure Daylight Saving Time
<b>Local</b>	Web User Interface	Configure the NTP Primary server, Secondary server, time zone and Upgrade interval. Configure the time and date manually. Configure the time and date formats. Configure Daylight Saving Time Navigate to: <a href="http://&lt;phoneIPAddress&gt;/fcgi/do?id=4&amp;id=1">http://&lt;phoneIPAddress&gt;/fcgi/do?id=4&amp;id=1</a>
	Phone User Interface	Configure the NTP Primary server, Secondary server, time zone and Upgrade interval. Configure the time and date manually. Configure the time and date formats. Enable or disable Daylight Saving

**To configure Format Setting via web user interface**

1. Click on **Phone > Time/Lang**
2. Select the desired value from pull-down list of **Time Format**
3. Select the desired value from pull-down list of **Date Format**
4. Select the desired value from pull-down list of **Display Format**

5. Press **Submit** to accept the change

**To configure Type via web user interface**

1. Click on **Phone > Time/Lang**
2. Mark the **Manual** or **Auto** radio box
3. If **Manual** is marked
4. Enter desired year, month, day, hour, minute and second in the **Year, Mon, Day, Hour, Min** and **Sec** fields

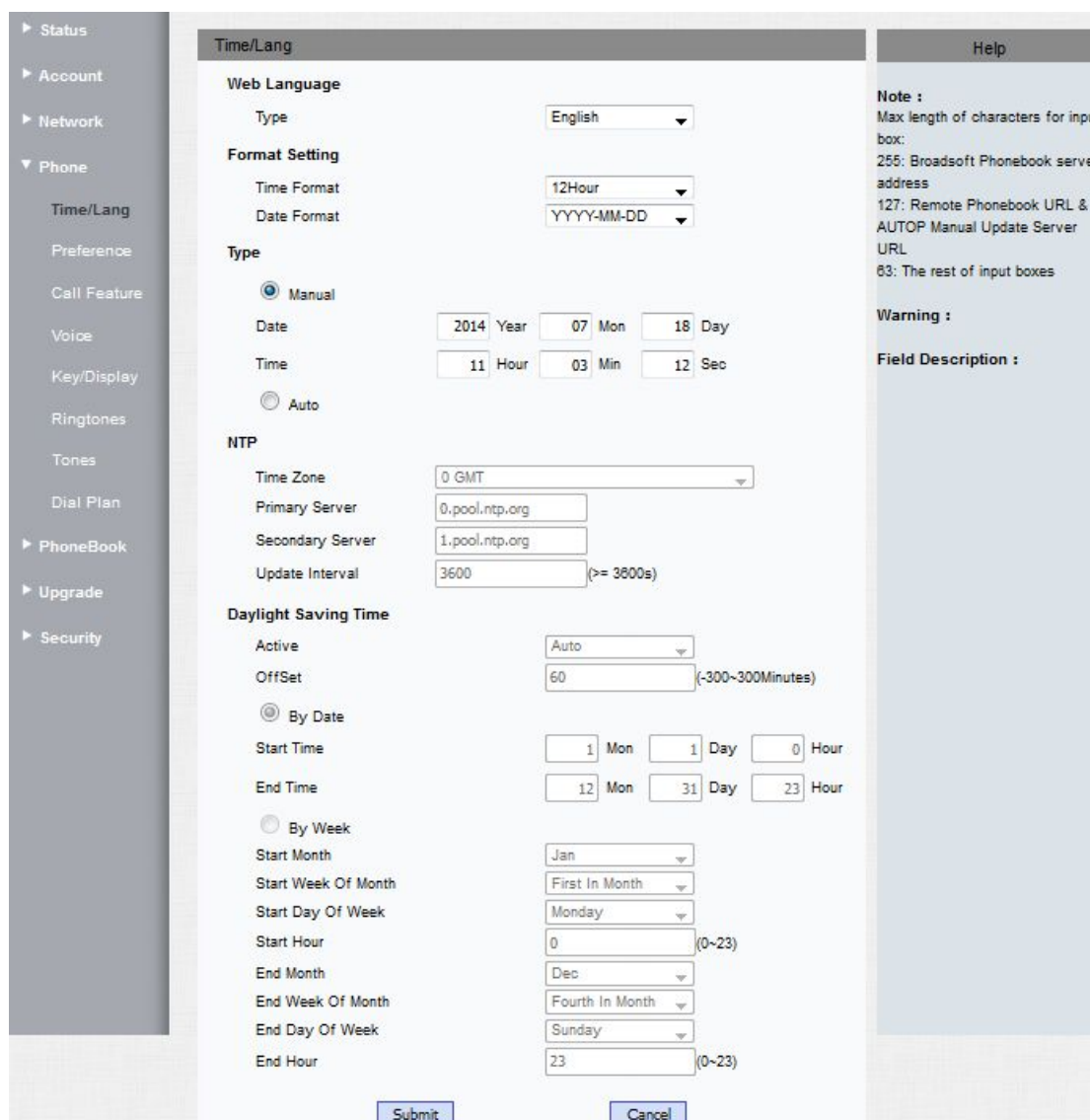

5. Press **Submit** to accept the change

### To configure NTP via web user interface

1. Click on **Phone > Time/Lang**.
2. **Auto** is marked in **Type**.
3. Select the desired value from pull-down list of **Time Zone**.
4. Enter the desired primary server address in the **Primary Server** field.
5. Enter the desired secondary server address in the **Secondary Server** field.
6. Enter the desired update interval in the **Update Interval** field.



The screenshot displays the 'Time/Lang' configuration page. On the left, a sidebar lists various settings categories. The main area is divided into several sections:

- Web Language:** Type is set to 'English'.
- Format Setting:** Time Format is '12Hour' and Date Format is 'YYYY-MM-DD'.
- Type:** 'Auto' is selected with a radio button. The date is set to 2014 Year, 07 Mon, 18 Day, and the time is 11 Hour, 03 Min, 12 Sec.
- NTP:** Time Zone is '0 GMT'. Primary Server is '0.pool.ntp.org' and Secondary Server is '1.pool.ntp.org'. Update Interval is '3600' (>= 3600s).
- Daylight Saving Time:** 'Active' is set to 'Auto' with an offset of '60' minutes. 'By Date' is selected. Start Time is 1 Mon, 1 Day, 0 Hour. End Time is 12 Mon, 31 Day, 23 Hour.

At the bottom of the form, there are 'Submit' and 'Cancel' buttons. On the right side, there is a 'Help' section with a 'Note' and a 'Warning'.

6. Press **Submit** to accept the change

**To configure Daylight Saving Time via web user interface**

1. Click on **Phone > Time/Lang**.
2. Select the desired value from pull-down list of **Active**.
3. Enter the desired offset time in the **Offset (minutes)** field.
4. If **By Date** is marked, enter the desired start time in the **Mon, Day** and **Hour** fields of **Start Time**, and enter the desired end time in the **Mon, Day** and **Hour** fields of **End Time**
5. If **By Week** is marked, select the desired value from pull-down list of **Start Month**
6. Select the desired value from pull-down list of **Start Week Of Month**
7. Select the desired value from pull-down list of **Start Day Of Week**
8. Enter the desired start hour in **Start Hour** field.
9. Select the desired value from pull-down list of **End Month**
10. Select the desired value from pull-down list of **End Week Of Month**
11. Select the desired value from pull-down list of **End Day Of Week**
12. Enter the desired start hour in **End Hour** field.

The screenshot shows the 'Time/Lang' configuration page. On the left is a sidebar with navigation options: Account, Network, Phone (expanded), Time/Lang (selected), Preference, Call Feature, Voice, Key/Display, Ringtones, Tones, Dial Plan, PhoneBook, Upgrade, and Security. The main content area is titled 'Time/Lang' and includes sections for Web Language, Format Setting, Type, NTP, and Daylight Saving Time. The 'Daylight Saving Time' section is active, with 'Active' set to 'Enabled' and 'Offset' set to '60'. The 'By Week' radio button is selected, and fields for Start and End times are visible. The 'Help' section on the right contains a 'Note' and a 'Warning'.

13. Press **Submit** to accept the change



## Language

IP phones support multiple languages. Languages on the phone user interface and web user interface can be customized. The default language used on the phone user interface and web user interface is English.

The following table lists languages supported by the phone user interface and the web user interface respectively.

Phone User Interface	Web User Interface
English	English
简体中文	简体中文
繁体中文	繁体中文
Русский	Русский
한국어	Español
Português	Nederlands
Español	
Italiano	
Nederlands	
French	

### Procedure

Specify the language for the phone user interface or the web user interface using the configuration files or locally.

<b>Configuration File</b>	<r000000000xx>.conf/<MAC>.conf	Specify the languages for the phone user interface and the web user interface.
<b>Local</b>	Web User Interface	Specify the languages for the web user interface. Navigate to: <a href="http://&lt;phoneIPAddress&gt;/fcgi/do?id=4&amp;id=1">http://&lt;phoneIPAddress&gt;/fcgi/do?id=4&amp;id=1</a>

	Phone User Interface	Specify the languages for the phone user interface.
--	----------------------	---

### To specify the language for the web user interface via web user interface via user interface:

1. Click on **Phone > Time/Lang**.
2. On **web language**, select the desired language from the pull-down list of **Type**

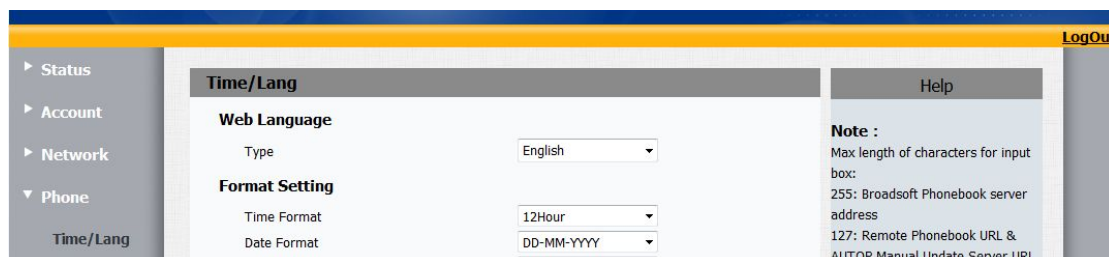

3. Click **Submit** to accept the change.

### To specify the language for the phone user interface via phone user interface:

1. Press **Menu > Settings > Basic Setting > Language**
2. Press **Up** or **Down** to select the desired language
3. Press the **Save** to accept the change

## Soft key Layout

Users can customize the soft keys layout at the bottom of the LCD screen to fulfill users' need. Soft key on idle screen can be configured. The configuration can be done on web, on phone, or by modifying configuration file.

The following table lists soft keys available for IP phones in different call states.

Call State		Soft keys	Optional
Idle		History Book DND Menu	MSG Status Fwd PickUp Group PickUp Intercom Speed Dial Favorites Redial Call Return Hot Desking XML Browser
Call Failure		Empty Empty Empty Cancel	
Incoming		Answer Fwd Silence Reject	
outgoing		Empty Empty Empty Cancel	
Forward		Back 123 Delete Ok	
Talking	Talk	Trans Hold New Cancel	

	<b>Hold</b>	Trans Resume New Cancel	
	<b>Held</b>	Empty Empty Hold Cancel	
	<b>New</b>	Send 123 Select Exit	
	<b>Transfer</b>	Trans 123 Select Exit	
	<b>Conference</b>	Empty Hold Split Cancel	

**Procedure**

Soft key layout can be configured using the configuration files or locally.

<b>Configuration File</b>	<r0000000000xx>.conf/<MAC>.conf	Configure the soft key layout.
<b>Local</b>	Web User Interface	Configure the soft key layout. Navigate to: <a href="http://&lt;phoneIPAddress&gt;/fcgi/do?id=4&amp;id=4">http://&lt;phoneIPAddress&gt;/fcgi/do?id=4&amp;id=4</a>
	Phone User Interface	Configure the soft key layout.

**To configure soft key layout via web user interface:**

1. Click on **Phone > Key/Display**.
2. On **Soft Key**, select the desired value from the pull-down list of **Type** for **Soft Key 1**.
3. Enter the desired label on **Label**, and If there is **Value** or **Account** available, enter or select the desired values.
4. Repeat the step 2 and 3 to configure more soft keys

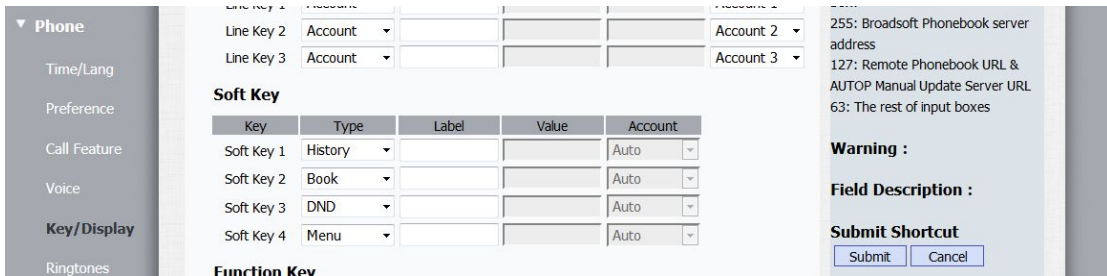

5. Click **Submit** to accept the change.

**To configure soft key layout via Phone user interface:**

1. Press **Menu > Features > Programmable Keys > Soft Key**
2. Press **Up** or **Down** to highlight **Soft Key 1**, then press **Enter**
3. Press **Left** or **Right** to select the desired **Type**
6. Enter the desired label on **Label**, and if there is **Value** or **Account** available, enter or select the desired values.
4. Press **Save** to accept the changes
5. Repeat step 2, 3 and 4 to configure more soft keys

## Key as Send

Key as send allows assigning the pound key as a send key.

**Procedure**

Key as send can be configured using the configuration files or locally.

<b>Configuration File</b>	<r0000000000xx>.conf/<MAC>.conf	Configure a send key.
<b>Local</b>	Web User Interface	Configure a send key. Navigate to: <a href="http://&lt;phoneIPAddress&gt;/fcgi/do?id=4&amp;id=2">http://&lt;phoneIPAddress&gt;/fcgi/do?id=4&amp;id=2</a>

Phone User Interface

Configure a send key.

**To configure a send key via web user interface:**

1. Click on **Phone > Call Feature**
2. On key As Send, select the desired value from the pull-down list

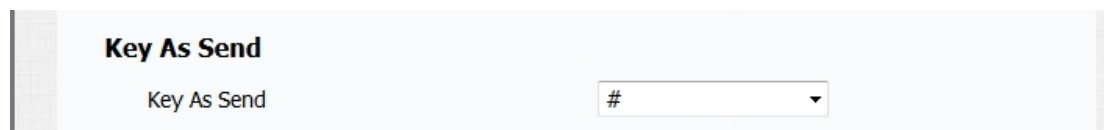

3. Press **Click** to accept the change.

**To configure a send key via Phone user interface:**

1. Press **Menu > Features > Key As Send**
2. Press Left or **Right** to select the desired value

## Dial Plan

A Dial Plan is a specially crafted text string, or script, that specifies how to interpret digit sequences as dialed by the VoIP user and how to convert those digit sequences into an outbound dial string to be used by your VoIP service provider (VSP) for call routing and termination.

Regular expression can be used to define IP phone dial plan. Dial plan is a string of characters that governs the way for IP phones to process the inputs received from the IP phone's keypads. IP phones support the following dial plan features:

- Replace Rule
- Dial now
- Area Code

## Replace Rule

Replace rule is an alternative string that replaces the numbers entered by the user.

**Procedure**

Akuvox Proprietary and Confidential. Copyright © 2014 Akuvox network Co., Ltd..

Replace rule can be created locally.

<p><b>Local</b></p>	<p>Web User Interface</p>	<p>Create the replace rule for the IP phone.                  Navigate to:                  http://&lt;phoneIPAddress&gt;/fcgi/do?id=4&amp;i                  d=7</p>
---------------------	---------------------------	---

**To create a replace rule via web user interface:**

1. Click on **Phone > Dial Plan**
2. On **Rules**, select **Replace Rule**
3. Click on **Add**
4. On **Rules Modify**, select the desired account from the pull-down list of **Account**
5. Enter the string in the **Prefix** field
6. Enter the string in the **Replace** field

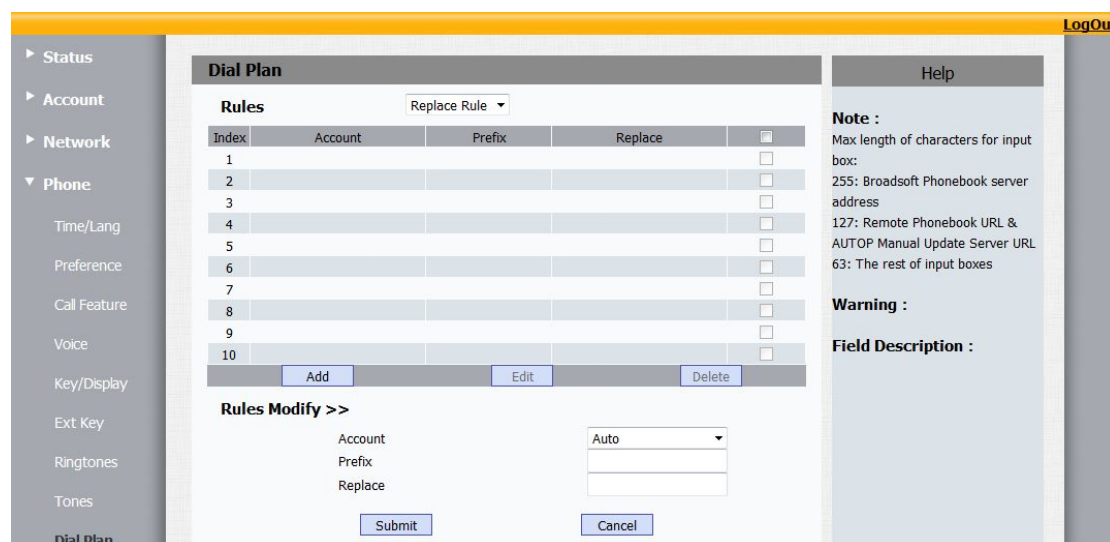

7. Click on **Submit** to accept the change

## Dial now

Dial-now is a string used to match numbers entered by the user. When entered numbers match the predefined dial-now rule, the IP phone will automatically dial out the numbers without pressing the send key.

### Delay Time for Dialnow Rule

The IP phone will automatically dial out the entered number, which matches the dial-now rule, after a specified period of time.

**Procedure**

Dial-now rule can be created using the configuration files or locally.

<b>Configuration File</b>	<r0000000000xx>.conf/<MAC>.conf	Configure the delay time for the dial-now rule.
<b>Local</b>	Web User Interface	<p>Create the dial-now rule for the IP phone. Configure the delay time for the dial-now rule.</p> <p>Navigate to: http://&lt;phoneIPAddress&gt;/fcgi/do?id=4&amp;id=7</p>

**To create a dial-now rule via web user interface:**

1. Click on **Phone > Dial Plan**
2. On **Rules**, select **Dial Now**
3. Click on **Add**
4. On **Dial Now Delay**, enter the desired value (0~15s)
5. On **Rules Modify**, select the desired account from the pull-down list of **Account**
6. Enter the string in the **Dial Now Rule** field

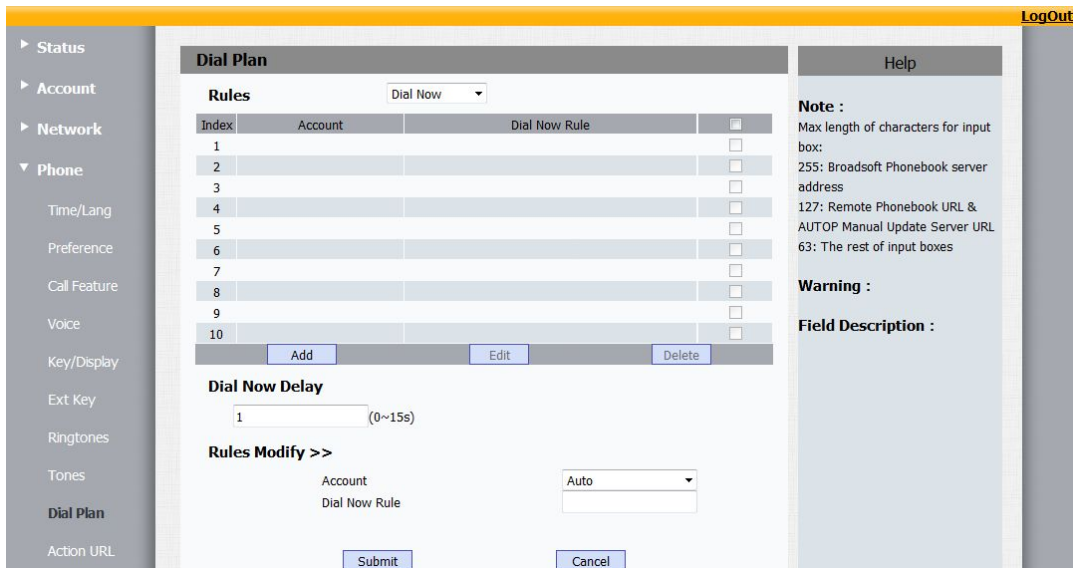

7. Click on **Submit** to accept the change

**Area Code**

Area codes are also known as Numbering Plan Areas (NPAs). They usually indicate geographical areas in one country. When entered numbers match the predefined area code rule, the IP phone will automatically add the area code before the numbers when dialing out



them. IP phones only support one area code rule.

**Procedure**

Area code rule can be configured using the configuration files or locally.

<b>Configuration File</b>	<r0000000000xx>.conf/<MAC>.conf	Create the area code rule and specify the maximum and minimum lengths of entered numbers.
<b>Local</b>	Web User Interface	Create the area code rule and specify the maximum and minimum lengths of entered numbers. Navigate to: <a href="http://&lt;phoneIPAddress&gt;/fcgi/do?id=4&amp;id=7">http://&lt;phoneIPAddress&gt;/fcgi/do?id=4&amp;id=7</a>

**To configure an area code rule via web user interface:**

1. Click on **Phone > Dial Plan**
2. On **Area Code**, enter the desired code in the **Code** field
3. Enter the desired min length (1~15) in **Min length** field
4. Enter the desired max length (1~15) in **Max length** field
5. Select the desired account from the pull-down list of **Account**

The screenshot shows a web form titled "Area Code". It contains the following fields and values:

- Code:** An empty text input field.
- Min Length:** A text input field containing the value "1", with "(1~15)" displayed to its right.
- Max Length:** A text input field containing the value "1", with "(1~15)" displayed to its right.
- Account:** A dropdown menu with "Auto" selected.

At the bottom of the form, there are two buttons: "Submit" and "Cancel".

6. Click on **Submit** to submit the change

## Hotline

Hotline allows the IP phone to dial out the hotline number automatically by the first available line after a specified time interval when off-hook. It is a point-to-point communication link in which a call is automatically directed to the preset hotline number. IP phones only support one hotline number.

**Procedure**

Hotline can be configured using the configuration files or locally.

<p><b>Configuration File</b></p>	<p>&lt;r000000000xx&gt;.conf/&lt;MAC&gt;.conf</p>	<p>Configure the hotline number. Specify the time (in seconds) the IP phone waits before automatically dialing out the hotline number.</p>
<p><b>Local</b></p>	<p>Web User Interface</p>	<p>Configure the hotline number. Specify the time (in seconds) the IP phone waits before automatically dialing out the hotline number. Navigate to: <a href="http://&lt;phoneIPAddress&gt;/fcgi/do?id=4&amp;id=2">http://&lt;phoneIPAddress&gt;/fcgi/do?id=4&amp;id=2</a></p>
	<p>Phone User Interface</p>	<p>Configure the hotline number. Specify the time (in seconds) the IP phone waits before automatically dialing out the hotline number.</p>

**To configure hotline via web user interface:**

1. Click on **Phone > Call Feature**
2. On **HotLine**, select the **Enable** from the pull-down list of **Active**
3. Enter desired number in **Number** field
4. Enter desired delay time (0~5s) in **Delay Time** field

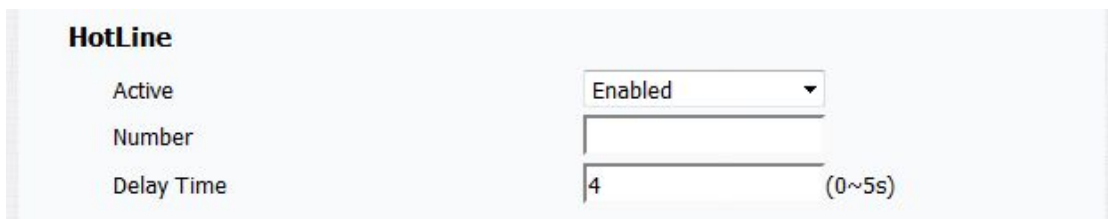

5. Click on **Submit** to accept the change

**To configure hotline via phone user interface:**

1. Press **Menu > Features > Hot Line**
2. Press **Up** or **Down** to highlight **Active** , press **Left** or **Right** to **Enable**
3. Press **Up** or **Down** to highlight **Number**, enter the desired number
4. Press **Up** or **Down** to highlight **Timeout(0-5)**, press **Left** or **Right** to select the desired value

5. Press **Save** to accept the change

## Local Phonebook

The Local Phone Book is used for storing the contacts names and number. IP Phones can store up to 500 entries contacts. You can add, edit, delete, search, or call any contact from the Local Phone Book.

### Procedure

Local contacts can be added locally.

<b>Local</b>	Web User Interface	Manually add contacts Navigate to: <a href="http://&lt;phoneIPAddress&gt;/fcgi/do?id=5&amp;id=1">http://&lt;phoneIPAddress&gt;/fcgi/do?id=5&amp;id=1</a>
	Phone User Interface	Manually add contacts

### To add Group to the Phone Book via web user interface:

1. Click on **Phonebook > Local Book**
2. On **Group Setting**, enter the desired name in **Name** field
3. Select the desired ring tone from the pull-down list of **Ring**
4. Enter the desired group description in **Description** field

**Group**

Index	Name	Ring	Description	<input type="checkbox"/>
1				<input type="checkbox"/>
2				<input type="checkbox"/>
3				<input type="checkbox"/>
4				<input type="checkbox"/>
5				<input type="checkbox"/>

**Group Setting**

Name

Ring

Description

5. Click **Add** to add the group to the Phone Book.

**To add contact to the Phone Book via web user interface:**

1. Click on **Phonebook > Local Book**.
2. On **Contact Setting**, enter the desired name in **Name** field.
3. Enter the desired mobile number in **Mobile Num** field
4. Enter the desired office number in **Office Num** field
5. Enter the desired other number in **Other Num** field
6. Select the desired account from the pull-down list of **Account**
7. Select the desired ring tone from the pull-down list of **Ring**
8. Select the desired group to add your new contact from the pull-down list of **Group**

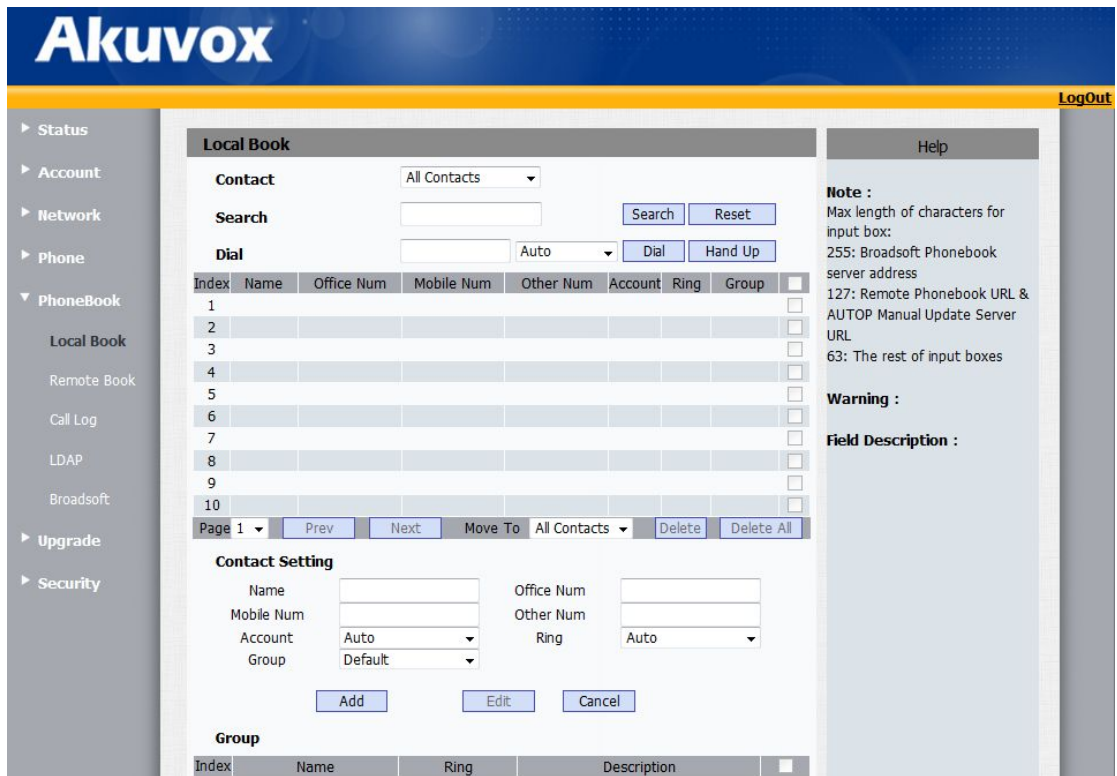

9. Click **Add** the add the new contact

**To add Group to the Phone Book via phone user interface:**

1. Press **Menu > Phone Book > Local Phone Book**
2. Press **Add** to add a new group
3. Press **Up** or **Down** to highlight **Name**, enter the group name.
4. Press **Up** or **Down** to highlight **RingTone**, press **Left** or **Right** to select the desired ring tone.
5. Press **Save** to accept the change

**To add contact to the Phone Book via phone user interface:**

1. Press **Menu > Phone Book > Local Phone Book**
2. Press **Up** or **Down** to select the desired group to add new contact, then press **Enter**
3. Press **Add** to add the new contact

4. Press **Up** or **Down** to highlight **Name**, enter the contact name
5. Press **Up** or **Down** to highlight **Office Number/Mobile Number/Other Number**, enter the desired office, mobile and other numbers
6. Press **Up** or **Down** to highlight **RingTone**, press **Left** or **Right** to select the desired ring tone
7. **(Optional)** if you change your mind on group selection, press **Up** or **Down** to highlight **Group**, press **Left** or **Right** to select the desired group

## Call Log

Call log contains call information such as Type, Date, Time, Local Identity, Name and Number. It can be used to redial previous outgoing calls, return incoming calls, and save contact information from call log lists to the contact directory.

IP phones maintain a local call log. Call log consists of four lists: Dial Calls, Received Calls, Missed Calls and Forwarded Calls. Call log lists support 100 entries in all, and call log can be view via web or phone user interface

### To view call log via web:

1. Click on **PhoneBook > Call Log**
2. Select the desired type of call history from the pull-down list of **Call history**

Index	Type	Date	Time	Local Identity	Name	Number
1	Dialed	2014-07-17	05:13:31	2404984733@s.iop1.broadworks.net	Unknown	100@as.iop1.broadworks.net
2	Received	2014-07-15	11:39:34	102@192.168.10.231	100	100@192.168.10.231
3	Received	2014-07-15	11:38:19	102@192.168.10.231	Unknown	anonymous@192.168.10.231
4	Received	2014-07-15	11:32:32	102@192.168.10.231	Unknown	anonymous@192.168.10.231
5	Received	2014-07-15	08:32:08	2404984733@s.iop1.broadworks.net	Unknown	as.iop1.broadworks.net@s.iop1.broadworks.net
6	Received	2014-07-15	04:45:27	102@192.168.10.231	100	100@192.168.10.231
7	Received	2014-07-14	14:46:40	2404984733@s.iop1.broadworks.net	Unknown	as.iop1.broadworks.net@s.iop1.broadworks.net
8	Dialed	2014-07-14	14:17:23	2404984733@s.iop1.broadworks.net	Unknown	4732@as.iop1.broadworks.net
9	Dialed	2014-07-14	14:04:59	2404984733@s.iop1.broadworks.net	Unknown	4732@as.iop1.broadworks.net
10	Dialed	2014-07-14	13:57:58	2404984733@s.iop1.broadworks.net	Unknown	4732@as.iop1.broadworks.net
11	Dialed	2014-07-14	13:51:15	2404984733@s.iop1.broadworks.net	Unknown	4732@as.iop1.broadworks.net

### To view call log via web:

1. Press **History**
2. Press **Up** or **Down** to select the specific number, press **OK** to view more information about the call

**To add number from call log to Contact/Blacklist:**

1. Press **History**
2. Press **Up** or **Down** to select the specific number, press **Option**.
3. Press **Up** or **Down** to highlight **Add to Contacts/Add to Blacklist**, press **OK**.
  - a) If **Add to Contacts** selected
    - Press Up or Down to highlight **Name/OfficeNumber/MobileNumber/Other Number/RingTone/Group/Account**
    - Enter or press **Left** or **Right** to select the desired value
    - Press **Save** to accept the change
  - b) If **Add to Blacklist** selected
    - Press **OK** to add to blacklist

## Missed Call Log

Missed call log allows the IP phone to display the number of missed calls with an indicator icon on the idle screen, and to log missed calls in the Missed Calls list when the IP phone misses calls.

**Procedure**

Missed call log can be configured using the configuration files or locally.

<b>Configuration File</b>	<r0000000000xx>.conf/<MAC>.conf	Configure missed call log. Navigate to: <a href="http://&lt;phoneIPAddress&gt;/fcgi/do?id=3&amp;id=2">http://&lt;phoneIPAddress&gt;/fcgi/do?id=3&amp;id=2</a>
<b>Local</b>	Web User Interface	Configure missed call log.

**To configure missed call log via web user interface:**

1. Click on **Account > Advanced**
2. Select the desired account from the pull-down list of **SIP ACCOUNT**
3. On **Call**, select the desired value from the pull-down list of **Missed Call Log**

Call		Field Description :
Max Local SIP Port	5063 (1024~65535)	<b>Submit Shortcut</b> <input type="button" value="Submit"/> <input type="button" value="Cancel"/>
Min Local SIP Port	5063 (1024~65535)	
Caller ID Header	FROM	
Auto Answer	Disabled	
Ringtones	Default	
Provisional Response ACK	Disabled	
user=phone	Disabled	
PTime	20	
Anonymous Call	Disabled	
Anonymous Call Rejection	Disabled	
Is escape non Ascii character	Enabled	
Missed Call Log	Enabled	

4. Click **Submit** to accept the change

## Call Waiting

Call waiting is a feature on some telephone networks. If a calling party places a call to a called party which is otherwise engaged, and the called party has the call waiting feature enabled, the called party is able to suspend the current telephone call and switch to the new incoming call, and can then negotiate with the new or the current caller an appropriate time to ring back.

### Procedure

Call waiting and call waiting tone can be configured using the configuration files or locally.

<b>Configuration File</b>	<r0000000000xx>.conf/<MAC>.conf	Configure call waiting and call waiting tone.
<b>Local</b>	Web User Interface	Configure call waiting and call waiting tone. Navigate to: <a href="http://&lt;phoneIPAddress&gt;/fcgi/do?id=4&amp;id=2">http://&lt;phoneIPAddress&gt;/fcgi/do?id=4&amp;id=2</a>
	Phone User Interface	Configure call waiting and call waiting tone.

### To configure call waiting via web user interface:

1. Click on **Phone > Call Feature**
2. On **Call Waiting**

3. Select the desired value from the pull-down list of **Call Waiting Enable**
4. Select the desired value from the pull-down list of **Call Waiting Tone**

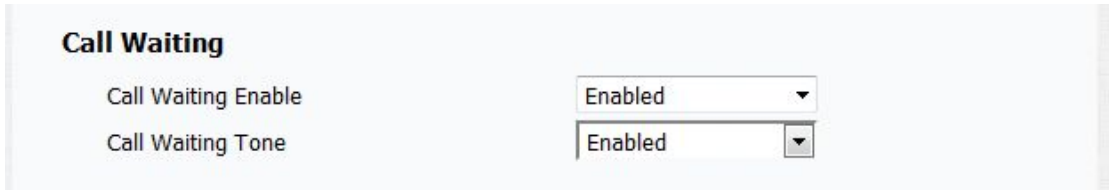

5. Click on **Submit** to accept the change

**To configure call waiting via Phone user interface:**

1. Press **Menu > Features > Call Waiting**
2. Press **Up** or **Down** to highlight **Active** , press **Left** or **Right** to select the desired value
3. Press **Up** or **Down** to highlight **Active** , press **Left** or **Right** to select the desired value
4. Press **Save** to accept the changes

## Auto Redial

If auto redial is enabled, the IP phone will attempt to redial a number when it was busy. Auto redial times and auto redial interval can be configured.

**Procedure**

Auto redial can be configured using the configuration files or locally.

<b>Configuration File</b>	<r0000000000xx>.conf/<MAC>.conf	Configure auto redial feature.
<b>Local</b>	Web User Interface	Configure auto redial feature. Navigate to: <a href="http://&lt;phoneIPAddress&gt;/fcgi/do?id=4&amp;id=2">http://&lt;phoneIPAddress&gt;/fcgi/do?id=4&amp;id=2</a>
	Phone User Interface	Configure auto redial feature.

**To configure auto redial via web user interface:**

1. Click on **Phone > Call Feature**
2. On **Auto Redial**, select the desired value from the pull-down list of **Auto Redail**
3. Enter the desired value of **Auto Redial interval**
4. Enter the desired value of **Auto Redial Times**



Auto Redial	
Auto Redial	Disabled
Auto Redial Interval	10 (1~300s)
Auto Redial Times	3 (1~100)

5. Press **Submit** to accept the change

**To configure auto redial via phone user interface:**

1. Press **Menu > Features > Auto Redial**
2. Press **Up** or **Down** to highlight **Active** , press **Left** or **Right** to select the desired value
3. Press **Up** or **Down** to highlight **Interval** , enter the desired value in **Interval** field
4. Press **Up** or **Down** to highlight **Times** , enter the desired value in **Times** field
5. Press **Save** to accept the changes

## Auto Answer

Auto answer allows IP phones to answer an incoming call automatically. But when the user is in a call, the phone will not answer the incoming call even if it is enabled. Auto answer is configurable on a per-line basis. Auto Answer delay defines the time. After this period of delay time the IP phone will answers incoming calls automatically.

**Procedure**

Auto answer can be configured using the configuration files or locally.

<b>Configuration File</b>	<r0000000000xx>.conf/<MAC>.conf	Configure auto answer. Specify a period of delay time for auto answer.
<b>Local</b>	Web User Interface	Configure auto answer. Specify a period of delay time for auto answer. Navigate to: <a href="http://&lt;phoneIPAddress&gt;/fcgi/do?id=3&amp;id=2">http://&lt;phoneIPAddress&gt;/fcgi/do?id=3&amp;id=2</a>
	Phone User Interface	Configure auto answer.

**To configure auto answer via web user interface:**

1. Click on **account > Advanced**

2. On **Call**, select the desired value from the pull-down list of Auto Answer



Configuration Item	Value	Range/Options
Max Local SIP Port	5062	(1024~65535)
Min Local SIP Port	5062	(1024~65535)
Caller ID Header	FROM	
Auto Answer	Disabled	
Provisional Response ACK	Disabled	
user=phone	Disabled	
PTime	20	
Anonymous Call	Disabled	
Anonymous Call Rejection	Disabled	

3. Click **Submit** to accept the change.

#### To configure auto answer via phone user interface:

1. Click on **Menu > Settings > Advanced Setting**
2. Enter the password (password: admin) in **Password** field.
3. Press **Up** or **Down** to highlight **Account**, and then press **Enter**
4. Press **Up** or **Down** to highlight the desired account to be configured, and then press **Enter**
5. Press **Up** or **Down** to highlight **Auto Answer Active**, press **Left** or **Right** to select the desired value
6. Press **Save** to accept the change

#### To specify a period of delay time via web user interface:

1. Click on **Phone > Call Feature**
2. On **Others**, enter the desired value of **Auto Answer Delay**



Configuration Item	Value	Range/Options
Return Code When Refuse	486(Busy Here)	
Auto Answer Delay	0	(0~5s)

3. Click **Submit** to accept the changes

## Anonymous Call

When Anonymous call is enabled, the caller will not let the others to see his/her ID. On the callee's phone LCD screen will show an incoming call from anonymity.

**Procedure**

Anonymous call can be configured using the configuration files or locally.

<b>Configuration File</b>	<r0000000000xx>.conf/<MAC>.conf	Configure anonymous call.
<b>Local</b>	Web User Interface	Configure anonymous call. Navigate to: http://<phoneIPAddress>/fcgi/do?id=3&id=2

**To configure anonymous call via web user interface:**

1. Click on **Account > Advanced**
2. On **Call**, select the desired value from the pull-down list of **Anonymous**

**Call**

Max Local SIP Port	5062	(1024~65535)
Min Local SIP Port	5062	(1024~65535)
Caller ID Header	FROM	
Auto Answer	Disabled	
Provisional Response ACK	Disabled	
user=phone	Disabled	
PTime	20	
Anonymous Call	Disabled	
Anonymous Call Rejection	Disabled	

3. Click **Submit** to accept the change

## Anonymous Call Rejection

IP phone users can reject the incoming calls that identity has been intentionally concealed by using the anonymous call rejection.

**Procedure**

Anonymous call rejection can be configured using the configuration files or locally.

<b>Configuration File</b>	<r0000000000xx>.conf/<MAC>.conf	Configure anonymous call rejection.
<b>Local</b>	Web User Interface	Configure anonymous call rejection. Navigate to: http://<phoneIPAddress>/fcgi/do?id=3&id=2

**To configure anonymous call rejection via web user interface:**

1. Click on **Account > Advanced**
2. On **Call**, select the desired value from the pull-down list of **Anonymous Call Rejection**

**Call**

Max Local SIP Port	5062	(1024~65535)
Min Local SIP Port	5062	(1024~65535)
Caller ID Header	FROM	▼
Auto Answer	Disabled	▼
Provisional Response ACK	Disabled	▼
user=phone	Disabled	▼
PTime	20	▼
Anonymous Call	Disabled	▼
Anonymous Call Rejection	Disabled	▼

3. Click **Submit** to accept the changes

## Do Not Disturb

If a user activates Do Not Disturb (DND), it will prevent all calls. DND can be activated or deactivated via DNA soft key. In addition, the DND on code and DND off code are used to activate/deactivate the server-side DND feature. They may vary according to different servers.

### Return Message When DND

This feature defines the return code and the reason of the SIP response message for the rejected incoming call when DND is enabled on the IP phone. The caller's phone LCD screen

displays the received return code. There are three return code available, 486(Busy Here), 404(Not Found) and 480(Temporarily Unavailable)

**Procedure**

DND can be configured using the configuration files or locally.

<b>Configuration File</b>	<r0000000000xx>.conf/<MAC>.conf	Configure DND
<b>Local</b>	Web User Interface	Configure DND Navigate to: http://<phoneIPAddress>/fcgi/do?id=4&id=2
	Phone User Interface	Configure DND

**To configure DND via web user interface:**

1. Click on **Phone > Call Feature**
2. On **DND**, select the desired value from the pull-down list of **DND**
3. Select the desired value from the pull-down list of **Return Code When DND**
4. Enter the desired value in **DND On Code**
5. Enter the desired value in **DND Off Code**

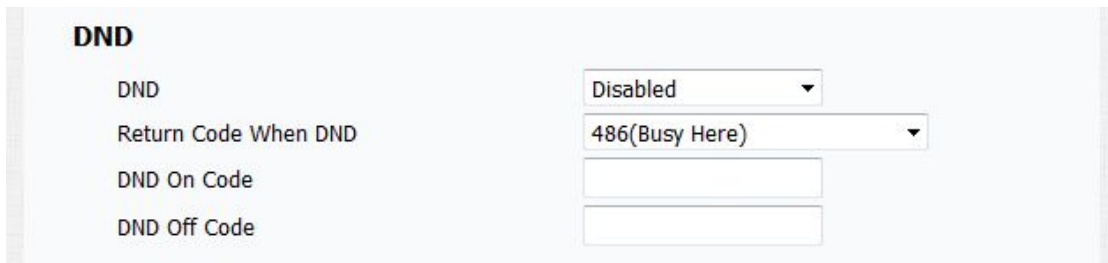

6. Click **Submit** to accept the changes

**To configure DND via phone user interface:**

1. Press **Menu > Features > DND Code**
2. Press **Up** or **Down** to highlight **Active**, press **Left** or **Right** to select the desired value
3. Press **Up** or **Down** to highlight **On Code**, enter the desired value
4. Press **Up** or **Down** to highlight **Off Code**, enter the desired value
5. Press **Save** to accept the change

## Return Code When Refuse

- Return code when refuse provisions the return code and reason of the SIP response message for the refused call. According to the received return code, the reason will be

displayed on the caller's phone LCD screen.

Available return codes and reasons are:

- 404 (Not Found)
- 480 (Temporarily not available)
- 486 (Bust here)

**Procedure**

Return code for refused call can be configured using the configuration files or locally.

<b>Configuration File</b>	<r0000000000xx>.conf/<MAC>.conf	Specify the return code and the reason of the SIP response message when refusing a call.
<b>Local</b>	Web User Interface	Specify the return code and the reason of the SIP response message when refusing a call.  Navigate to: <a href="http://&lt;phoneIPAddress&gt;/fcgi/do?id=4&amp;id=2">http://&lt;phoneIPAddress&gt;/fcgi/do?id=4&amp;id=2</a>

**To specify the return code and the reason when refusing a call via web user interface:**

1. Click on **Phone > Call feature**
2. On **Others**, select the desired value from the pull-down list of **Return Code When Refuse**

3. Click **Submit** to accept the change

## Early Media

Before a SIP call is established, the phone will play the early media (e.g., audio and video) to the caller. Current implementation supports early media through the 183 message. When the caller receives a 183 message with SDP before the call is established, a media channel is established. This channel is used to provide the early media stream for the caller.

## Session Timer

Session timer allows a periodic refresh of SIP sessions through a re-INVITE request, to determine if a SIP session is still active. If session timer is enabled, the ongoing call will be disconnected automatically once the session expired unless it's been refreshed by UAC or UAS.

### Procedure

Session timer can be configured using the configuration files or locally

<b>Configuration File</b>	<r0000000000xx>.conf/<MAC>.conf	Configure session timer
<b>Local</b>	Web User Interface	Configure session timer Navigate to: http://<phoneIPAddress>/fcgi/do?id=3&id=2

### To configure session timer via web user interface:

1. Click on **Account > Advanced**
2. On **Session Timer**, select the desired value from the pull-down list of **Active**
3. Enter the desired value in **Session Expire** field
4. Select the desired value from the pull-down list of **Session Refresher**

5. Click **Submit** to accept the change

## Call Forward

Users can redirect an incoming call to a third party by this function. IP phones redirect an incoming INVITE message by responding with a 302 Moved Temporarily message, which contains a Contact header with a new URI that should be tried.

There are three types of call forward: Forward the incoming call immediately (Always Forward); Forward the incoming call when the line is busy (Busy Forward); Forward the incoming call after a few seconds of ring time (No Answer Forward).

**Procedure**

Call forward can be configured using the configuration files or locally.

<b>Configuration File</b>	<r0000000000xx>.conf/<MAC>.conf	Configure call forward
<b>Local</b>	Web User Interface	Configure call forward Navigate to: http://<phoneIPAddress>/fcgi/do?id=4&id=2
	Phone User Interface	Configure call forward

**To configure call forward via web user interface:**

1. Click on **Phone > Call Feature**
2. On **Forward Transfer**, select the desired value from the pull-down list of **Always Forward/Busy Forward/No Answer Forward**
3. Enter the destination number you want to forward in the **Target Number** field
4. Enter the on code and off code in the **On Code** and **Off Code** fields
5. Enter the ring time to wait before forwarding from the pull-down list of **No Answering Ring Time (0~45s)** (only for the no answer forward)

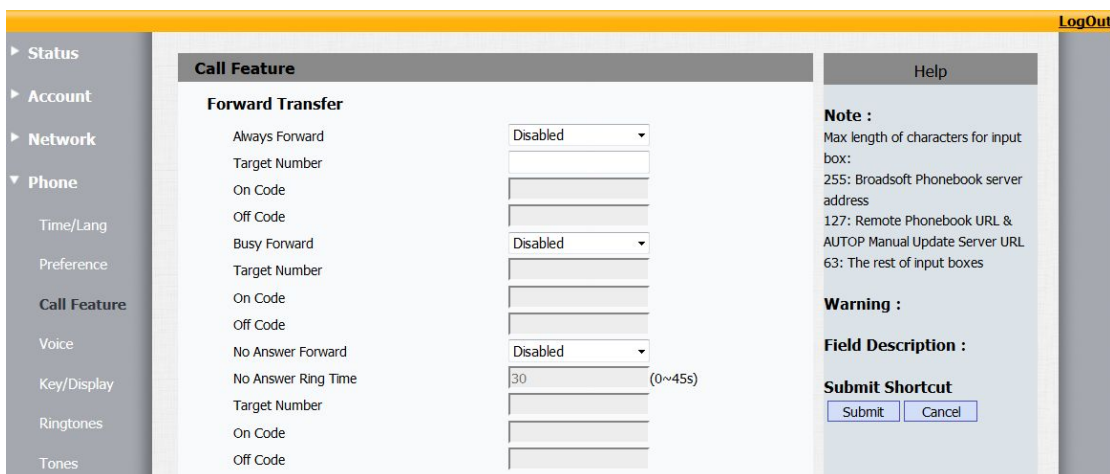

6. Click **Submit** to accept the change

**To configure call forward in phone mode via phone user interface:**

1. Press **Menu > Features > Call Forward**
2. Press **Up** or **Down** to select the desired forwarding type, and then press **Enter** to enter.
3. Depending on your selection:
  - a) If **Always Forward** is selected
    - 1) Press **Up** or **Down** to highlight **Active**, select the desired value from the



- pull-down list of **Active**
- 2) Press **Up** or **Down** to highlight **Forward To**, enter the destination number you want to forward to
- 3) Press **Up** or **Down** to highlight **On Code**, enter the desired value in **On Code** field
- 4) Press **Up** or **Down** to highlight **Off Code**, enter the desired value in **Off Code** field
- 5) Press **Save** to accept the change
- b) If **Busy Forward** is selected
  - 1) Press **Up** or **Down** to highlight **Active**, select the desired value from the pull-down list of **Active**
  - 2) Press **Up** or **Down** to highlight **Forward To**, enter the destination number you want to forward to
  - 3) Press **Up** or **Down** to highlight **On Code**, enter the desired value in **On Code** field
  - 4) Press **Up** or **Down** to highlight **Off Code**, enter the desired value in **Off Code** field
  - 5) Press **Save** to accept the change
- c) If **No Answer Forward** is selected
  - 1) Press **Up** or **Down** to highlight **Active**, select the desired value from the pull-down list of **Active**
  - 2) Press **Up** or **Down** to highlight **Forward To**, enter the destination number you want to forward to
  - 3) Press **Up** or **Down** to highlight **On Code**, enter the desired value in **On Code** field
  - 4) Press **Up** or **Down** to highlight **Off Code**, enter the desired value in **Off Code** field
  - 5) Press **Up** or **Down** to highlight **Timeout**, enter the ring time to wait before forwarding
  - 6) Press **Save** to accept the change

## Call Transfer

Call transfer enables IP phones to transfer an existing call to another party. There are three types when A wants to transfer to B:

- a) **Blind transfer:**
  - 1) A presses **Transfer** soft key to hold B

- 2) A inputs C's number, then press **Transfer** key. After that, A returns to standby mode
  - 3) After C answers, the line between B and C gets through
- b) **Semi-Attended Transfer:**
- 1) A presses **Transfer** soft key to hold B
  - 2) A input C's number, then press **OK** key, after that, before C answers, A end call, A returns to standby mode
  - 3) After C answers, the line between B and C gets through
- c) **Attended Transfer:**
- 1) A presses **Transfer** soft key to hold B
  - 2) An inputs C's number, then press **OK** key. After C answers, the line between A and C gets through
  - 3) A presses **Transfer** soft key, after that, A returns to standby mode, the line between B and C gets through

## 3-Way Conference

You can use the local conference feature to hold a 3-way conference by pressing the Conference soft key to invite the current talking and one line talking held to attend conference. The Network conference feature allows you to add or delete the party who attend the conference.

The local conference feature of IP phone can invite two parties at most to attend conference. The conference type of IP phone is Local conference with default.

### a. Create Local Conference

1. Create talking with first party;
2. Press the **New** soft key to create a new talking;
3. Press the **Back** soft key of dial interface to hold talking with first party.
4. Input the number of second party and press the **OK** key on the phone keyboard or the **Dial** key or the **Send** soft key to make a call; When the second party answer your call, inquire whether they want to attend conference;
5. Press the **Conference** soft key to start 3-way conference.
6. Press the **Split** soft key to split to two lines standalone talking, then this two parties talking are under Hold status:
7. **HOLD** Press the Resume soft key to resume the current talking:
8. Press the **Cancel** soft key to cancel the conference talking and return to Idle :

### b. Make two lines talking attend conference

1. Use two different accounts to create two lines talking in the phone (For example, use account 1 to create line 1 talking and account 2 for line 2).
2. Press the **Up** or **Down** key on the phone keyboard to select the talking you will create for conference, the talking must be on activated status ( For example, select the talking in account 1)
3. Press the **Conference** soft key to add the two lines talking to conference.

**Note**

You can press the **Hold** soft key to hold the conference; also you can press the **Split** soft key to split the conference to two standalone talking, press the **Cancel** soft key to end conference.

## Call Pickup

Directed call pickup is used for picking up an incoming call on a specific extension. A user can pick up the incoming call using a PickUp soft key.

**Procedure**

Call pickup can be configured using the configuration files or locally.

<b>Configuration File</b>	<r000000000xx>.conf/<MAC>.conf	Assign a pickup key. Configure pickup key
<b>Local</b>	Web User Interface	Assign a pickup key. Configure pickup key Navigate to: <a href="http://&lt;phoneIPAddress&gt;/fcgi/do?id=4&amp;id=4">http://&lt;phoneIPAddress&gt;/fcgi/do?id=4&amp;id=4</a>
	Phone User Interface	Assign a pickup key. Configure pickup key

**To set a specified call pickup key via web user interface:**

1. Click on **Phone > Key/Display**
2. Select the desired key to set **PickUp** by selecting from the pull-down list of **Type of Line Key/Soft Key/Function Key/DSS Key** (DSS Key only applicable to R59)
3. Enter the desired value in the **Label** field, if **Label** is applicable (Label only applicable to

Line Key, Soft Key)

4. Enter the desired pickup target in the **Value** field
5. Select the desired account from the pull-down list of **Account**

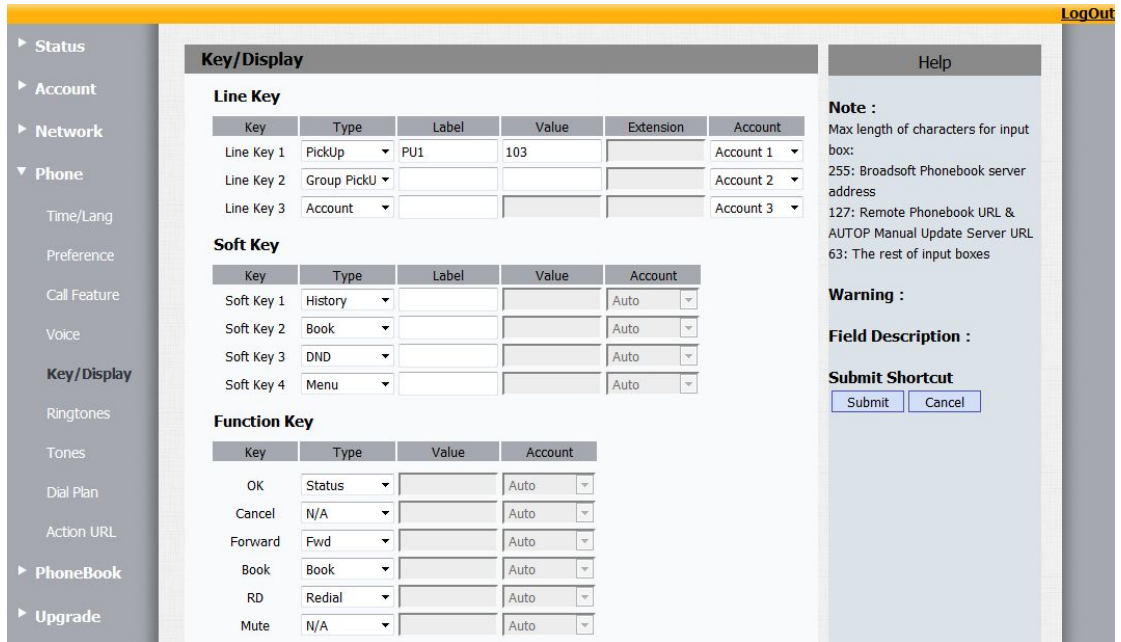

6. Click **Submit** to accept the change.

**To set a specified call pickup key via Phone user interface:**

1. Press **Menu > Features > Programmable Keys > Line Keys/Soft Keys/Function Keys/DSS Keys** (DSS Keys only applicable to R59)
2. Press **Up** or **Down** to select the desired key to be set to **PickUp**
3. Press **Up** or **Down** to highlight **Type**, press **Left** or **Right** to select **PickUp**
4. Press **Up** or **Down** to highlight **Label**, enter the desired value in **Label** if **Label** is applicable (Label only applicable to Line Key, Soft Key)
5. Press **Up** or **Down** to highlight **Value**, enter the desired pickup target in **Value**.
6. Press **Up** or **Down** to highlight **Account**, press **Left** or **Right** to select account
7. Press **Save** to accept the change

## Group Pickup

Group call pickup allows users to pick up incoming calls from a pre-defined group. To pick up an incoming call, using a Group Pickup soft key.

### Procedure

Call pickup can be configured using the configuration files or locally.

<b>Configuration File</b>	<r0000000000xx>.conf/<MAC>.conf	Assign a group pickup key. Configure group pickup key
<b>Local</b>	Web User Interface	Assign a group pickup key. Configure group pickup key Navigate to: <a href="http://&lt;phoneIPAddress&gt;/fcgi/do?id=3&amp;id=1">http://&lt;phoneIPAddress&gt;/fcgi/do?id=3&amp;id=1</a>
	Phone User Interface	Assign a group pickup key. Configure group pickup key

**To set a specified group pickup key via web user interface:**

1. Click on **Phone > Key/Display**
2. Select the desired key to set **Group PickUp** by selecting from the pull-down list of **Type** of **Line Key/Soft Key/Function Key/DSS Key** (DSS Key only applicable to R59)
3. Enter the desired value in the **Label** field if **Label** is applicable (Label only applicable to Line Key, Soft Key)
4. Enter the desired pickup target in the **Value** field
5. Select the desired account from the pull-down list of **Account**

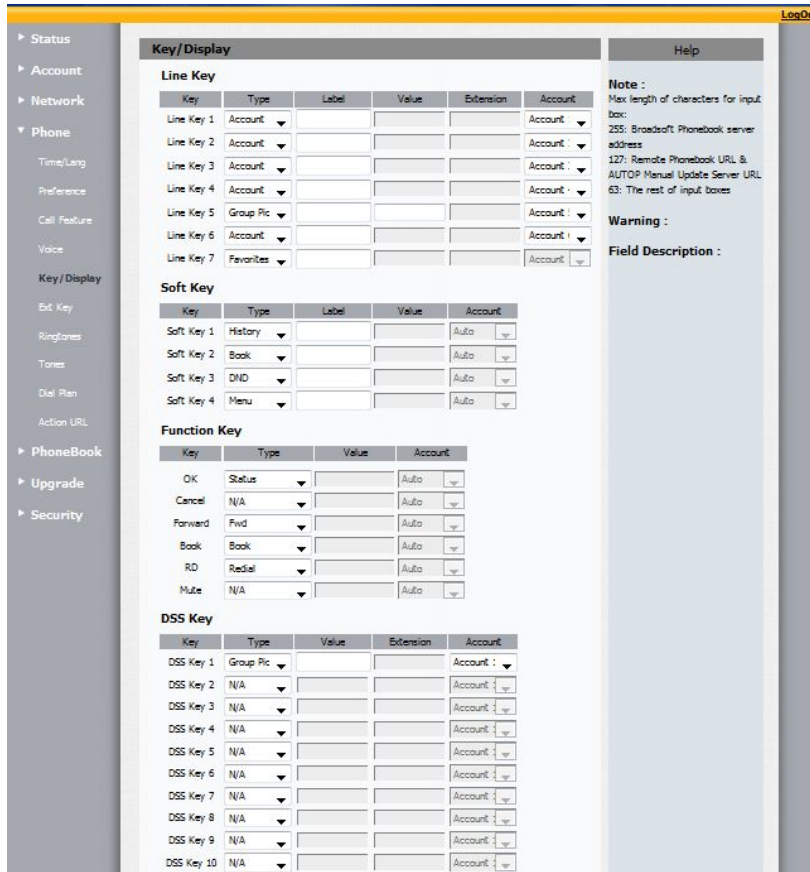

6. Press **Submit** to accept the change

**To set a specified group pickup key via Phone user interface:**

1. Press **Menu > Features > Programmable Keys > Line Keys/Soft Keys/Function Keys/DSS Keys** (DSS Keys only applicable to R59)
2. Press **Up** or **Down** to select the desired key to be set to **PickUp**
3. Press **Up** or **Down** to highlight **Type**, press **Left** or **Right** to select **Group PickUp**
4. Press **Up** or **Down** to highlight **Label**, enter the desired value in **Label** if **Label** is applicable (Label only applicable to Line Key, Soft Key)
5. Press **Up** or **Down** to highlight **Value**, enter the desired pickup target in **Value**
6. Press **Up** or **Down** to highlight **Account**, press **Left** or **Right** to select account
7. Press **Save** to accept the change

## Call Return

Call return allows users to place a call back to the last caller. Call return is implemented on IP phones using a call return key.

### Procedure

Call return key can be configured using the configuration files or locally.

<b>Configuration File</b>	<r0000000000xx>.conf/<MAC>.conf	Assign a call return key.
<b>Local</b>	Web User Interface	Assign a call return key. Navigate to: http://<phoneIPAddress>/fcgi/do?id=4&id=4
	Phone User Interface	Assign a call return key.

**To set a specified call return key via web user interface:**

1. Click on **Phone > Key/Display**
2. Select the desired key to set **Call Return** by selecting from the pull-down list of **Type** of **Line Key/Soft Key/Function Key/DSS Key** (DSS Key only applicable to R59)
3. Enter the desired value in the **Label** field if **Label** is applicable (Label only applicable to Line Key, Soft Key)

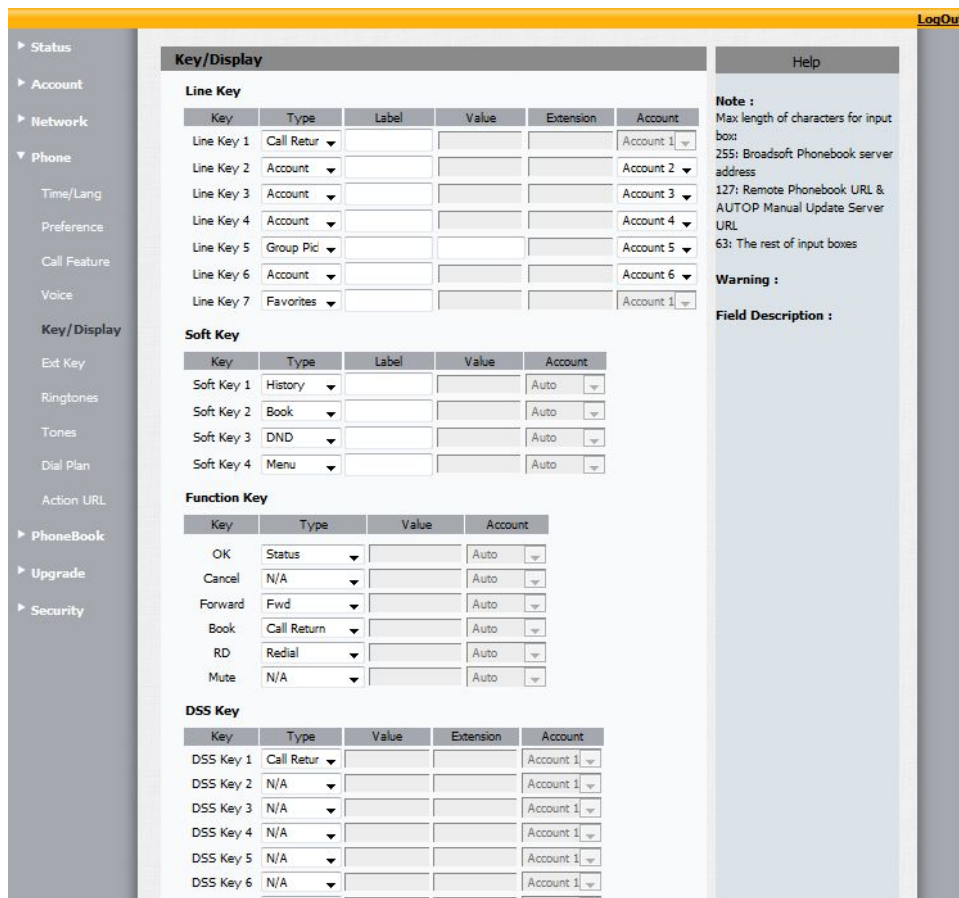

4. Press **Submit** to accept the change

**To set a specified call return key via Phone user interface:**

1. Press **Menu** > **Features** > **Programmable Keys** > **Line Keys/Soft Keys/Function Keys/DSS Keys** (DSS Keys only applicable to R59)
2. Press **Up** or **Down** to select the desired key to be set to **CallReturn**
3. Press **Up** or **Down** to highlight **Type**, press **Left** or **Right** to select **CallReturn**
4. Press **Up** or **Down** to highlight **Label**, enter the desired value in **Label** if **Label** is applicable (Label only applicable to Line Key, Soft Key)
5. Press **Up** or **Down** to highlight **Value**, enter the desired pickup target in **Value**
6. Press **Up** or **Down** to highlight **Account**, press **Left** or **Right** to select account
7. Press **Save** to accept the change

## Call Park

Call park allows a person to put a call on hold at one telephone set and continue the conversation from any other telephone set. This feature depends on support from a SIP server.

### Procedure

Call park can be configured using the configuration files or locally.

<b>Configuration File</b>	<r0000000000xx>.conf/<MAC>.conf	Configure call park feature
<b>Local</b>	Web User Interface	Configure call park feature Navigate to: <a href="http://&lt;phoneIPAddress&gt;/fcgi/do?id=4&amp;id=2">http://&lt;phoneIPAddress&gt;/fcgi/do?id=4&amp;id=2</a>
	Phone User Interface	Configure call park feature

### To configure call park via web user interface:

1. Click on **Phone** > **Call Feature**
2. On **Call Park**, select the desired value from the pull-down list of **Active**
3. Select the desired value from the pull-down list of **Account**
4. Enter the desired target number in the **Target** field

**Call Park**

Active

Account

Target

5. Press **Submit** to accept the change



**To configure call park via phone user interface:**

1. Press **Menu** > **Features** > **Call park**
2. Press **Up** or **Down** to Highlight **Active**, press **Left** or **Right** to select the desired value
3. Press **Up** or **Down** to Highlight **Target**, enter the desired target number
4. Press **Up** or **Down** to Highlight **account**, press **Left** or **Right** to select the desired account
5. Press **Save** the accept the change

## DTMF

DTMF stands for Dual Tone Multi-frequency, It is used for telecommunication signaling over analog telephone lines in the voice-frequency band between telephone handsets and other communications devices and the switching center.

The DTMF keypad is laid out in a 4x4 matrix in which each row represents a low frequency and each column represents a high frequency. Pressing a single key sends a sinusoidal tone for each of the two frequencies. For example, the key 1 produces a superimposition of tones of 697 and 1209 hertz (Hz).

DTMF keypad frequencies (Standard 12-button dialing pad)

	1209 Hz	1336 Hz	1477 Hz
697 Hz	1	2	3
770 Hz	4	5	6
852 Hz	7	8	9
941 Hz	*	0	#

Three methods of transmitting DTMF digits on SIP calls:

- **RFC 2833** -- DTMF digits are transmitted by RTP Events compliant to RFC 2833.
- **INBAND** -- DTMF digits are transmitted in the voice band.
- **SIP INFO** -- DTMF digits are transmitted by SIP INFO messages.

### RFC 2833

DTMF digits are transmitted using the RTP Event packets that are sent along with the voice path. These packets use RFC 2833 format and must have a payload type that matches what the other end is listening for. The payload type for RTP Event packets is configurable. IP phones default to 101 for the payload type, which use the definition to negotiate with the other end during call establishment.

The RTP Event packet contains 4 bytes. The 4 bytes are distributed over several fields denoted as Event, End bit, R-bit, Volume and Duration. If the End bit is set to 1, the packet contains the end of the DTMF event. You can configure the sending times of the end RTP Event packet.

**INBAND**

DTMF digits are transmitted within the audio of the IP phone conversation. It uses the same codec as your voice and is audible to conversation partners.

**SIP INFO**

DTMF digits are transmitted by the SIP INFO messages when the voice stream is established after a successful SIP 200 OK-ACK message sequence. The SIP INFO message is sent along the signaling path of the call. The SIP INFO message can support transmitting DTMF digits in three ways: DTMF, DTMF-Relay and Telephone-Event.

**Procedure**

Configuration changes can be performed using the configuration files or locally.

<b>Configuration File</b>	<r0000000000xx>.conf/<MAC>.conf	Configure the method of transmitting DTMF, DTMF Info Type and the payload type.
<b>Local</b>	Web User Interface	Configure the method of transmitting DTMF, DTMF Info Type and the payload type. Navigate to: http://<phoneIPAddress>/fcgi/do?id=3&id=2

**To configure DTMF via web user interface:**

1. Click on **Account > Advanced**
2. On **DTMF**, select the desired type from the pull-down list of **Type**
3. If Info is selected, select the DTMF info type from the pull-down list of **How to Notify DTMF**
4. Enter the desired value in DTMF Payload

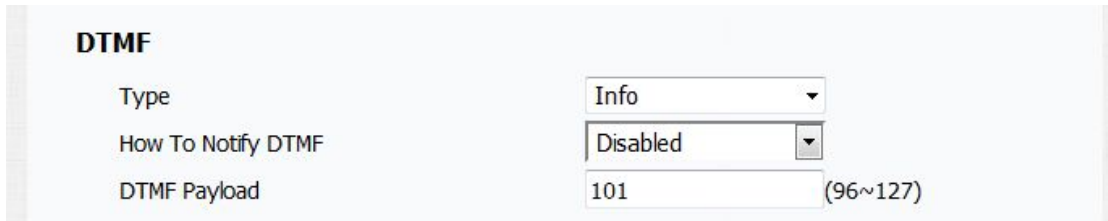

5. Press **Submit** to accept the change

## Intercom

Users can setup an audio conversation immediately by using this function. The IP phone can answer intercom calls automatically. This feature needs a SIP server to support.

### Procedure

Intercom and Intercom key can be configured using the configuration files or locally.

<b>Configuration File</b>	<r0000000000xx>.conf/<MAC>.conf	Configure intercom feature. Assign an intercom key.
<b>Local</b>	Web User Interface	Configure intercom feature. Assign an intercom key. Navigate to: <a href="http://&lt;phoneIPAddress&gt;/fcgi/do?id=4&amp;id=4">http://&lt;phoneIPAddress&gt;/fcgi/do?id=4&amp;id=4</a>
	Phone User Interface	Configure intercom feature. Assign an intercom key.

### To configure an intercom key via web user interface:

1. Click on **Phone > Key/Display**
2. Select **Intercom** from the pull-down list of **Type** of **Line Key/Soft Key/Function Key/DSS Key** (DSS keys only applicable to R59)
3. Enter the desired value in the **Label** field if **Label** is applicable (Label only applicable to Line Key, Soft Key)
4. Enter the desired target number in **Value** field
5. Select the desired account from the pull-down list of **Account**

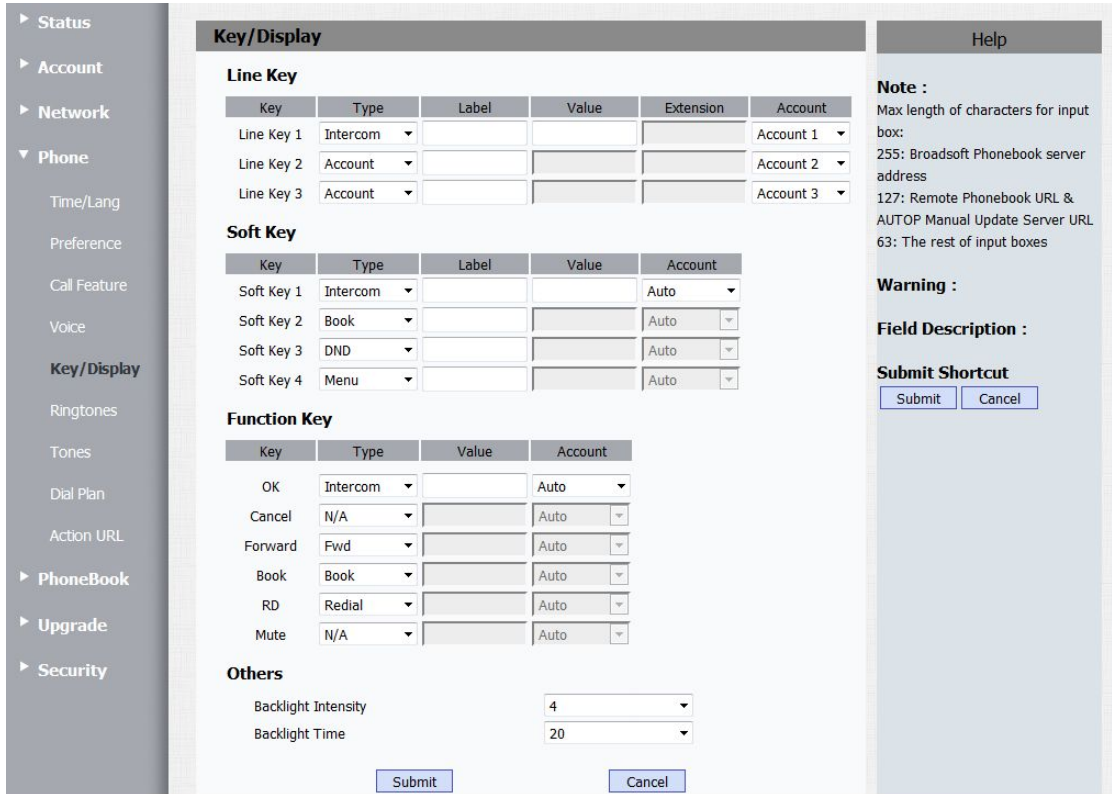

6. Press **Submit** to accept the change.

**To configure an intercom key via phone user interface:**

1. Press **Menu > features > Programmable Keys > Line Keys/Soft Keys/Function Keys/DSS Keys** (DSS keys only applicable to R59)
2. Press **Up** or **Down** to highlight **Type**, press **Left** or **right** to select **Intercom**
3. Press **Up** or **Down** to highlight **Label**, enter the desired value if **Label** is applicable (Label only applicable to Line Key and Soft Key)
4. Press **Up** or **Down** to highlight **Value**, enter the desired target number
5. Press **Up** or **Down** to highlight **Account**, press **Left** or **right** to select desired account
6. Press **Save** to accept the change

**To configure intercom via web user interface:**

1. Click on **Phone > Call Feature**
2. On **Intercom**, select the desired value from the pull-down list from **Active**.
3. Select the desired value from the pull-down list from **Intercom Mute**.



4. Click **Submit** to accept the change

**To configure intercom via phone user interface:**

1. Press **Menu** > **Features** > **Intercom**
2. Press **Up** or **Down** to highlight **Active**, press **Left** or **Right** to select the desired value.
3. Press **Up** or **Down** to highlight **Mute**, press **Left** or **Right** to select the desired value
4. Press **Save** to accept the change

## Configuring Advanced Features

This chapter provides information for making configuration changes for the following advanced features:

### Distinctive ring tones

When there is a certain incoming call, the IP phone will be triggered to play distinctive ring tones. When there is a call incoming, the IP phone inspects the INVITE request for an "Alert-Info" header, and the IP phone strips out the URL and keyword parameter and maps them to the appropriate ring tone.

Alert-Info headers in the following four formats:

Alert-Info: 127.0.0.1/Bellcore-drN

Alert-Info: ringtone-N (or Alert-Info: MyMelodyN)

Alert-Info: <URL>

Alert-Info: info=info text;x-line-id=0

If the Alert-Info header contains the keyword "Bellcore-drN", and the parameter "features.alert\_info\_tone" is set to 1, the IP phone will play the Bellcore-drN (N=1, 2, 3, 4 or 5) ring tone. Otherwise, the IP phone will play the preconfigured local ring tone in about ten seconds.

Example:

Alert-Info: http://127.0.0.1/Bellcore-dr1

If the Alert-Info header contains the keyword "ringtone-N", the IP phone will play the corresponding local ring tone (RingN.wav). Otherwise, the IP phone will play the preconfigured local ring tone in about ten seconds.

Example:

Alert-Info: ringtone-2

The following table identifies different ring tones.

Index	Keyword	Ringtone
0		Bellcore-dr1.wav
1		Bellcore-dr3.wav
2		Bellcore-dr5.wav
3		Ring1.wav
4		Ring2.wav
5		Ring3.wav
6		Ring4.wav
7		Ring5.wav
8		Ring6.wav
9		Ring7.wav
10		Ring8.wav
11		Ring9.wav

If the Alert-Info header contains a remote URL, and the parameter "account.X.alert\_info\_url\_enable" is set to 1 (the item called "Distinctive Ring Tones" on the web user interface is Enabled), the IP phone will try to download the WAV ring tone file from the URL and then play the remote ring tone. Otherwise, the IP phone will play the preconfigured local ring tone in about ten seconds.

Example:

Alert-Info: http://192.168.0.12:8080/Custom.wav

If the Alert-Info header contains an info text, the IP phone will map the text with the internal ringer text preconfigured, and then play the ring tone associated with the internal ringer text. Otherwise, the IP phone will play the preconfigured local ring tone in about ten seconds. "Bellcore-dr5" is a ring splash tone that reminds the user that the DND or Always Call. Forward feature is enabled on the server side.

Example:

Alert-Info: info=123A; x-line-id=0

**Procedure**

Distinctive ring tones can be configured using the configuration files or locally.

<b>Configuration File</b>	<r000000000xx>.conf/<MAC>.conf	Configure distinctive ring tones. Configure the internal ringer text and internal ringer file.
<b>Local</b>	Web User Interface	Configure distinctive ring tones.

		<p>Navigate to:  <a href="http://&lt;phoneIPAddress&gt;/fcgi/do?id=3&amp;id=2">http://&lt;phoneIPAddress&gt;/fcgi/do?id=3&amp;id=2</a></p> <p>Configure the internal ringer text and internal ringer file.</p> <p>Navigate to:  <a href="http://&lt;phoneIPAddress&gt;/fcgi/do?id=4&amp;id=5">http://&lt;phoneIPAddress&gt;/fcgi/do?id=4&amp;id=5</a></p>
--	--	---

**To configure distinctive ring tones via web user interface:**

1. Click on **Account**.
2. Click on **Advanced**.
3. Select the desired value from the pull-down list of **RingTones**.

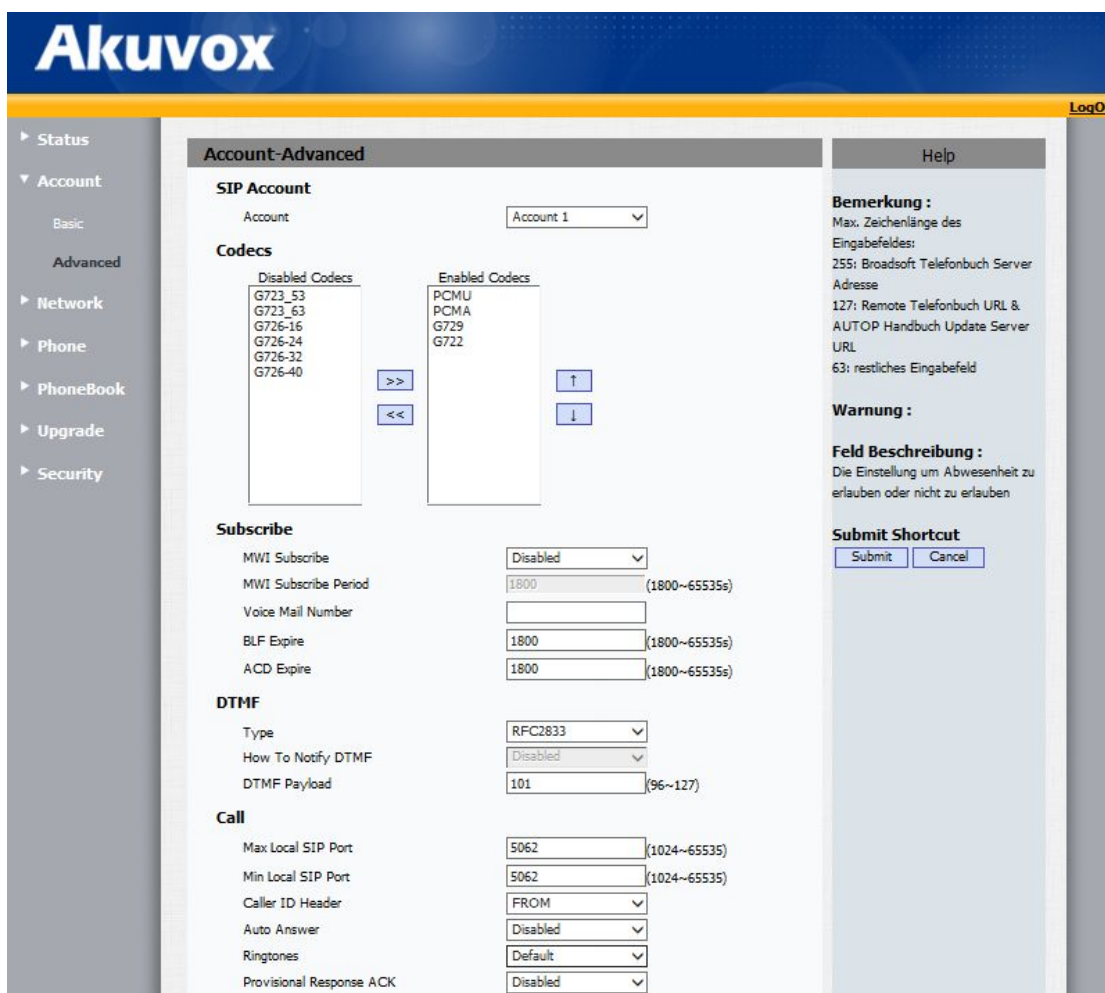

**To internal ringer text and internal ringer file via web user interface:**

1. Click on **Phone**.
2. Click on **Ringtones**.



4. Select **Distinctive Ringers**.

To configure the internal ringer text and internal ringer file via web user interface:

1. Enter the keywords in the **Text** fields.
2. Select the desired ring tones for each text from the pull-down lists of **Internal Ringer File**.

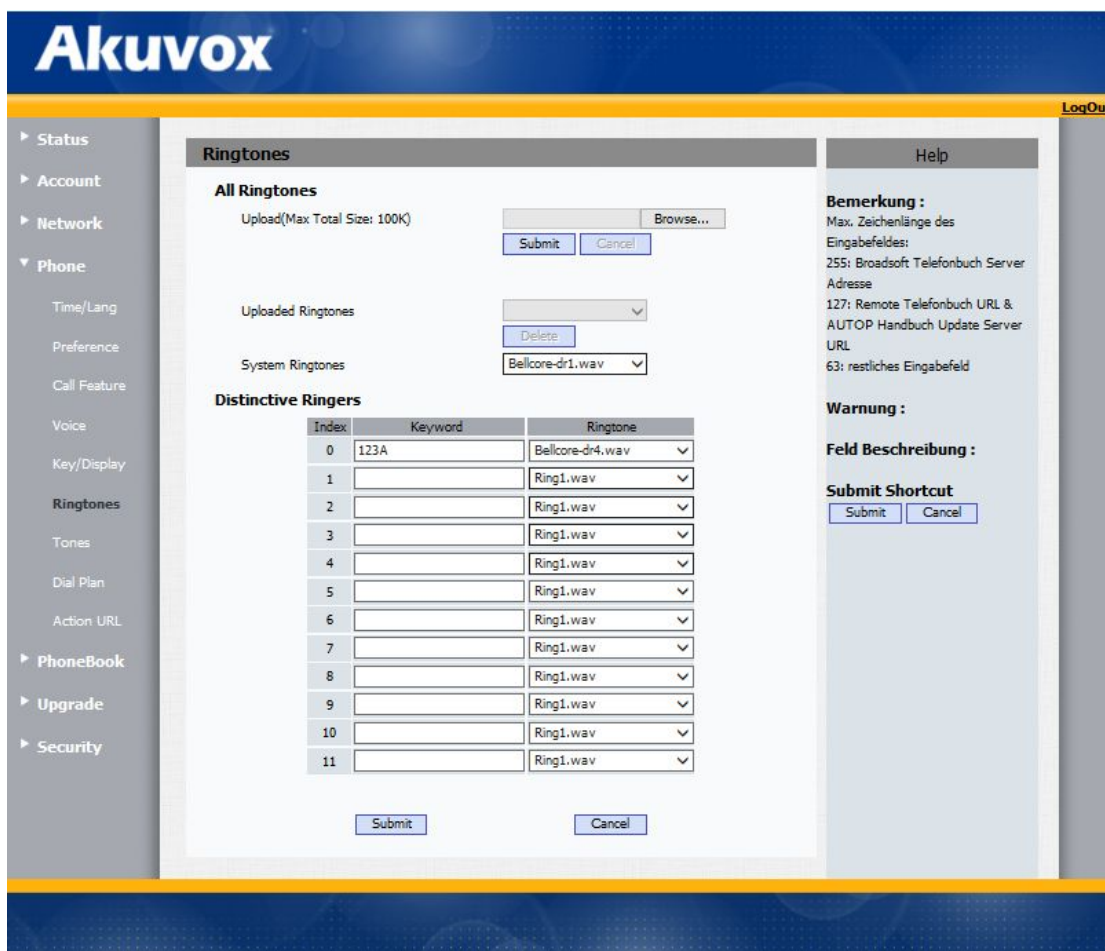

3. Click **Submit** to accept the change.

## Tones

The IP phone will be playing a warning tone when it receives a message. One is able to customize tones, and for different conditions of the IP phone, specialized tone set can be selected.

Available tone sets for IP phones:

- China

- Spain
- Luxembourg
- Sweden
- Taiwan
- Belgium
- Denmark
- Finland
- Germany
- Netherlands
- Norway
- Portugal

Configured tones can be heard on IP phones for the following conditions.

Condition	Description
Ring Back	Ring-back tone
Dial	When in the pre-dialing interface
Call Waiting	Call waiting tone

### Procedure

Tones can be configured using the configuration files or locally.

<b>Configuration File</b>	<r0000000000xx>.conf/<MAC>.conf	Configure the tones for the IP phone.
<b>Local</b>	Web User Interface	Configure the tones for the IP phone. Navigate to: <a href="http://&lt;phoneIPAddress&gt;/fcgi/do?id=4&amp;id=6">http://&lt;phoneIPAddress&gt;/fcgi/do?id=4&amp;id=6</a>

### To configure tones via web user interface:

1. Click on **Phone > Tones**.
  2. Select the desired type from the pull-down list of **Select Country**.
- If you select **Custom**, you can customize a tone for each condition of the IP phone.

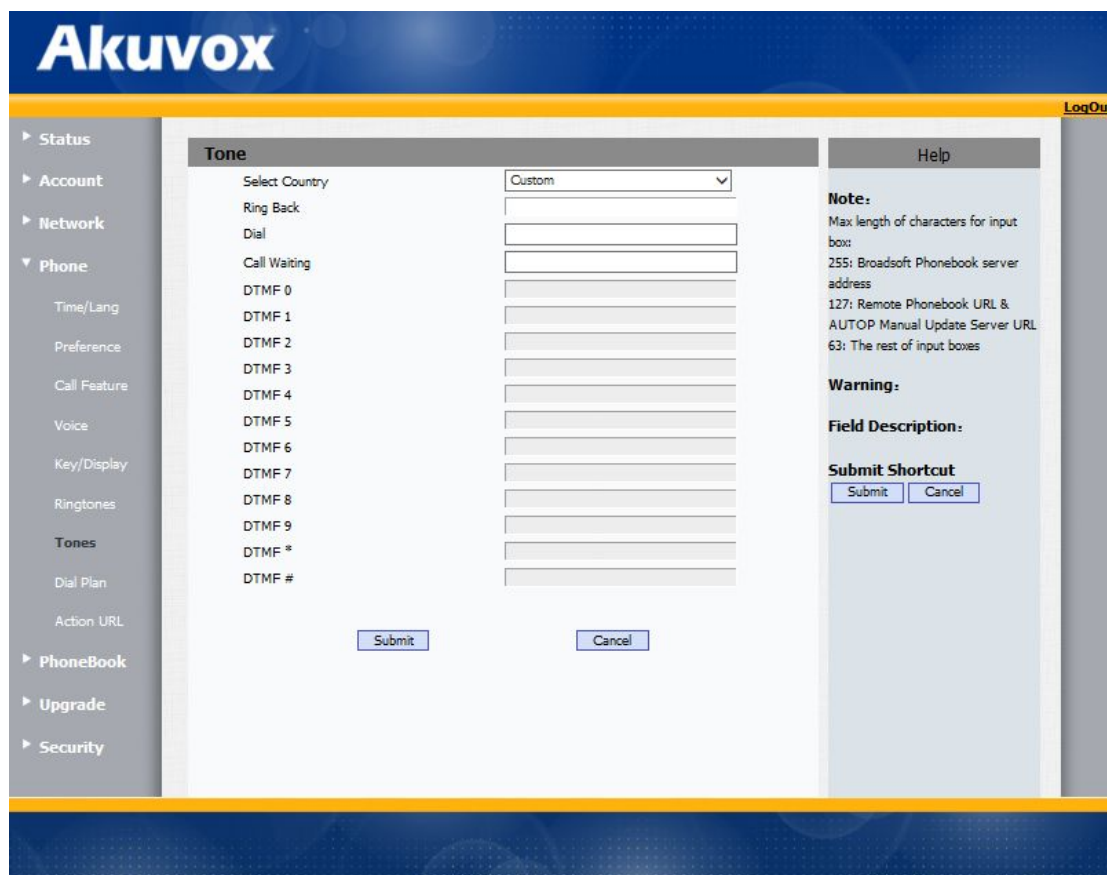

3. Click **Submit** to accept the change.

## Remote Phone Book

Users could access remote phonebook via the access URL of the remote phone book which is phone book stored on the remote server. The IP phone then will try to connect to the remote server and download the phone book, and display the remote phone book entries on the phone user interface. IP phones support up to 5 remote phone books.

### Procedure

Remote phone book can be configured using the configuration files or locally.

<b>Configuration File</b>	<r0000000000xx>.conf/<MAC>.conf	Specify the access URL of the remote phone book.
<b>Local</b>	Web User Interface	Specify the access URL of the remote phone book. Navigate to:

		<p>http://&lt;phoneIPAddress&gt;/cgi/do?id=5&amp;id=4</p>
--	--	---

To specify access URL of the remote phone book via web user interface:

1. Click on **PhoneBook > Remote Book**.
2. Enter the access URL in the **Remote URL** field.
3. Enter the name in the **Display Name** field.

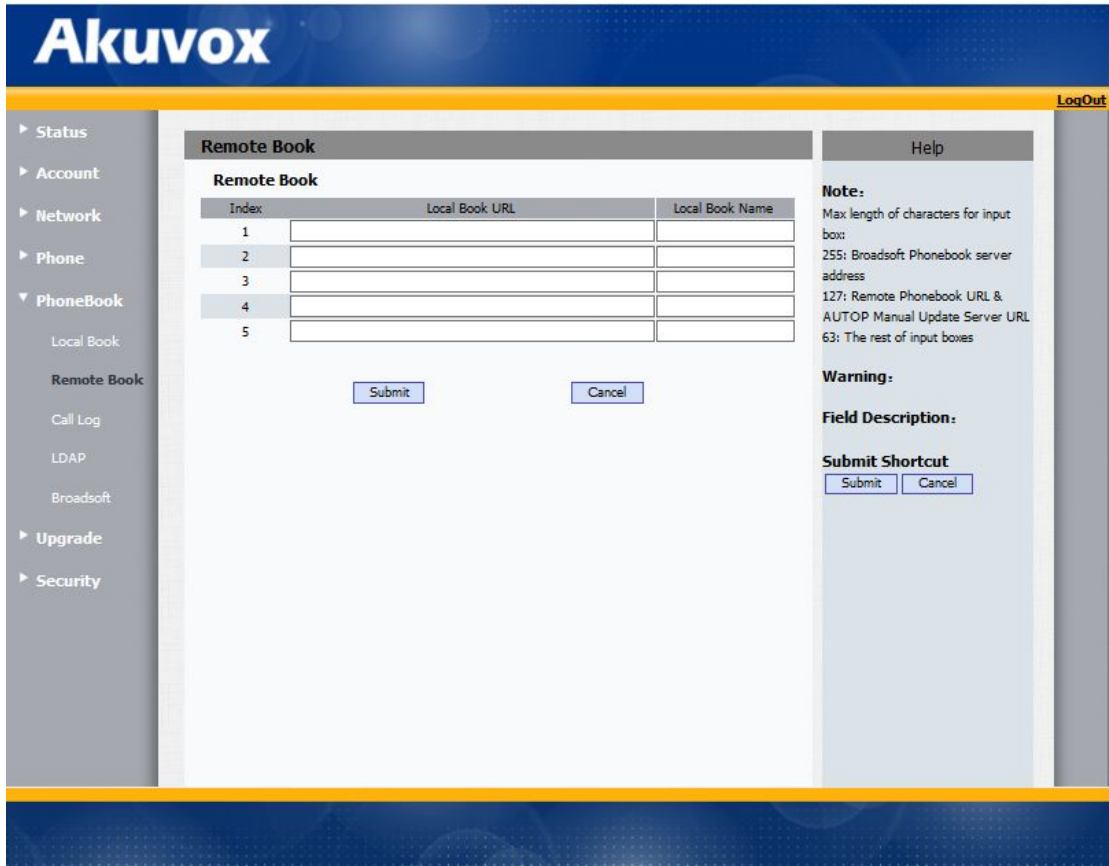

4. Click **Submit** to accept the change

## LDAP

LDAP stands for Lightweight Directory Access Protocol, is an application protocol for accessing and maintaining information services for the distributed directory over an IP network. IP phones can be configured to interface with a corporate directory server. Akuvox SP-R5Xp supports Open LDAP Directory

### LDAP Attributes

The following table lists the most common attributes used to configure the LDAP lookup on IP phones.

Abbreviation	Name	Description
cn	commonName	LDAP attribute is made up from given name joined to surname.
sn	surname	Last name or family name
-	telephoneNumber	Office phone number
mobile	mobilephoneNumber	Mobile or cellular phone number
-	homePhone	Home phone number

### Procedure

LDAP can be configured using the configuration files or locally.

<b>Configuration File</b>	<r000000000xx>.conf/<MAC>.conf	Configure LDAP.
<b>Local</b>	Web User Interface	Configure LDAP. Navigate to: <a href="http://&lt;phoneIPAddress&gt;/fcgi/do?id=5&amp;id=5">http://&lt;phoneIPAddress&gt;/fcgi/do?id=5&amp;id=5</a>

### To configure LDAP via web user interface:

1. Click on **Directory > LDAP**.
2. Enter the values in the corresponding fields.
3. Select the desired values from the corresponding pull-down lists.

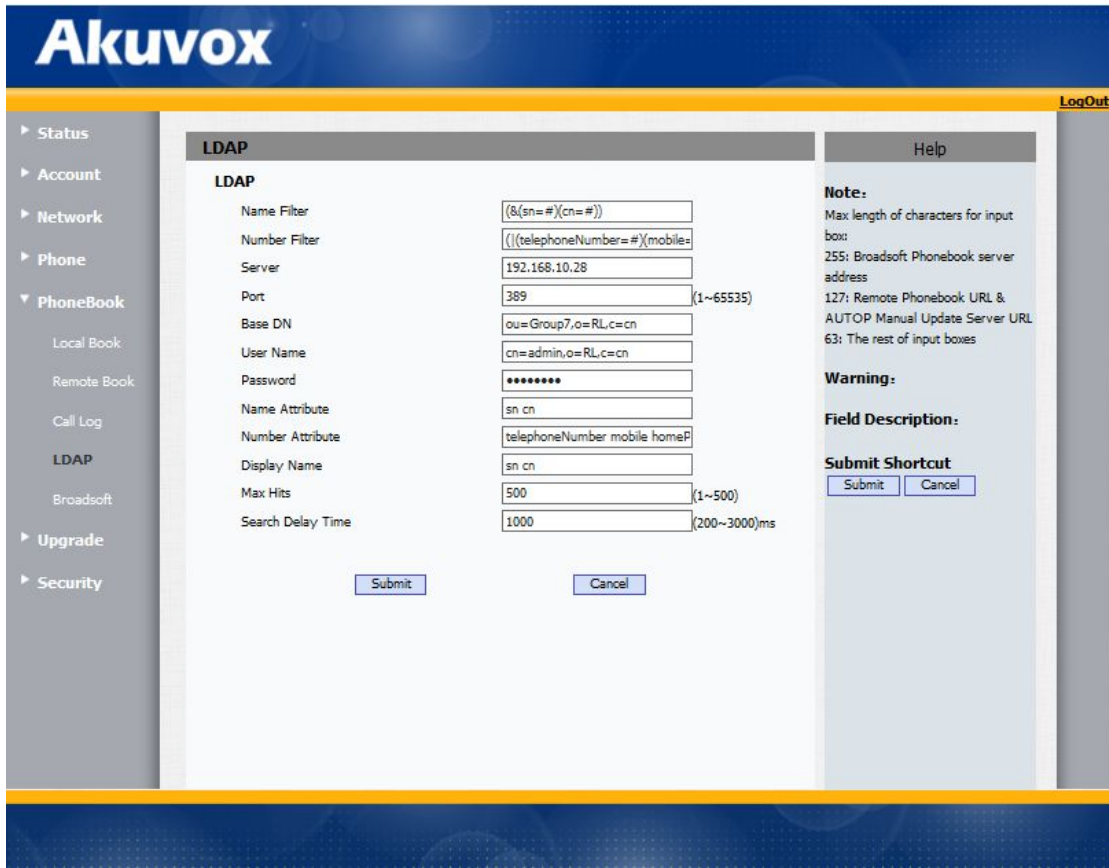

4. Click **Submit** to accept the change.

## Busy Lamp Field

Busy Lamp Field (BLF) is a light on an IP phone which tells you whether another extension connected to the same PBX is busy or not. When an IP phone is configured to monitor an extension it sends a SUBSCRIBE SIP message to the PBX. If authentication is configured, authentication takes place and if the subscriber is successfully authenticated a 200 OK SIP message response is sent back to the subscriber. A NOTIFY SIP message which includes XML in the message body is sent to the subscriber (in this case the phone) to advise the subscriber the current state of the extension being monitored. Once status of monitored extension is changed from idle to busy or vice versa, the subscriber is notified from the PBX with a NOTIFY SIP message.

When the monitored user is idle, the supervisor presses the BLF key to dial out the phone number. When the monitored user receives an incoming call, the supervisor presses the BLF key to pick up the call directly. When the monitored user is in a call, the supervisor presses the BLF key to interrupt and set up a conference call.

**Note:**

BLF feature is not applicable to SP-R50P IP phones.

**Visual BLF PickUp Alert**

When the monitored user receives an incoming call, the supervisor's phone will play an alert tone and display a visual prompt.

In addition to the BLF key, by pressing the programmed BLF soft key, the supervisor will pick up the monitored user's incoming call. The directed call pickup code must be configured in advance.

**Note:**

Visual alert for BLF pickup feature is not applicable to SP-R50P IP phone.

**BLF LED Mode**

BLF LED Mode provides two kinds of definition for the BLF key LED status.

**Line key LED**

LED Status	Description
Solid green	The monitored user is idle.
Fast flashing green	The monitored user receives an incoming call.
Slow flashing green	The monitored user is dialing. The monitored user is talking.
Off	The monitored user does not exist.

**DSS Key LED**

LED Status	Description
Solid green	The monitored user is idle.
Slow flashing red	The monitored user receives an incoming call.
Solid red	The monitored user is dialing. The monitored user is talking.
Off	The monitored user does not exist.

**Procedure**

BLF can be configured using the configuration files or locally.

<b>Configuration File</b>	<r000000000xx>.conf /<MAC>.conf	Specify whether to use visual alert and audio alert for BLF pickup. Assign a BLF key.
<b>Local</b>	Web User Interface	Assign a BLF key. Navigate to:

		<p>http://&lt;phoneIPAddress&gt;/fcgi/do?id=4&amp;id=4</p> <p>Specify whether to use visual alert and audio alert for BLF pickup.</p> <p>Navigate to:</p> <p>http://&lt;phoneIPAddress&gt;/fcgi/do?id=4&amp;id=2</p>
	Phone User Interface	Assign a BLF key.

**To configure a BLF key via web user interface:**

1. Click on **Phone->Key/Display->DSS Key (or Line Key)**.
2. In the desired **DSS key** field, select BLF from the pull-down list of **Type**.
3. Enter the phone number or extension you want to monitor in the **Value** field.
4. Select the desired line from the pull-down list of **Line**.
5. **(Optional)** Enter the directed call pickup code in the **Extension** field.

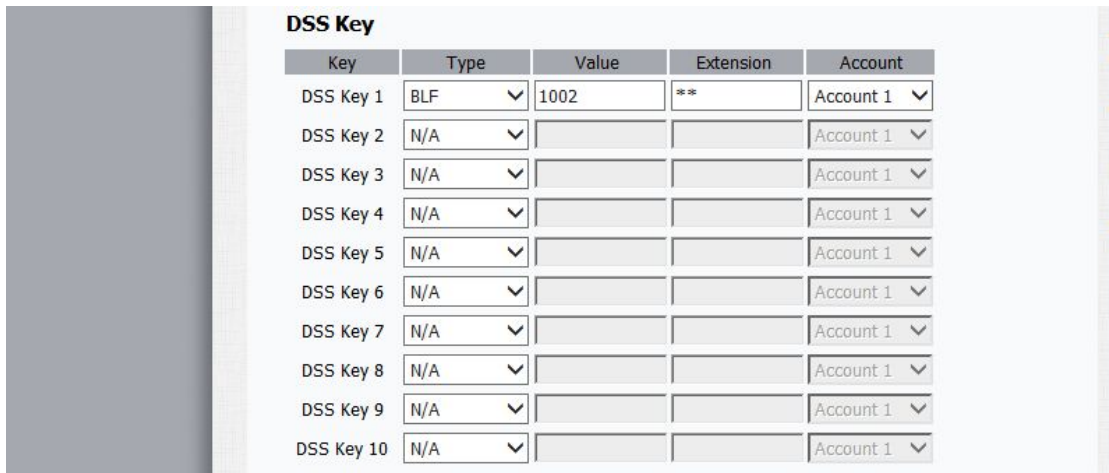

6. Click **Submit** to accept the change.

**To configure visual alert and audio alert for BLF pickup via web user interface:**

1. Click on **Phone > Call Features > Call Pickup**.
2. Select the desired value from the pull-down list of **Visual BLF Pickup Alert**.



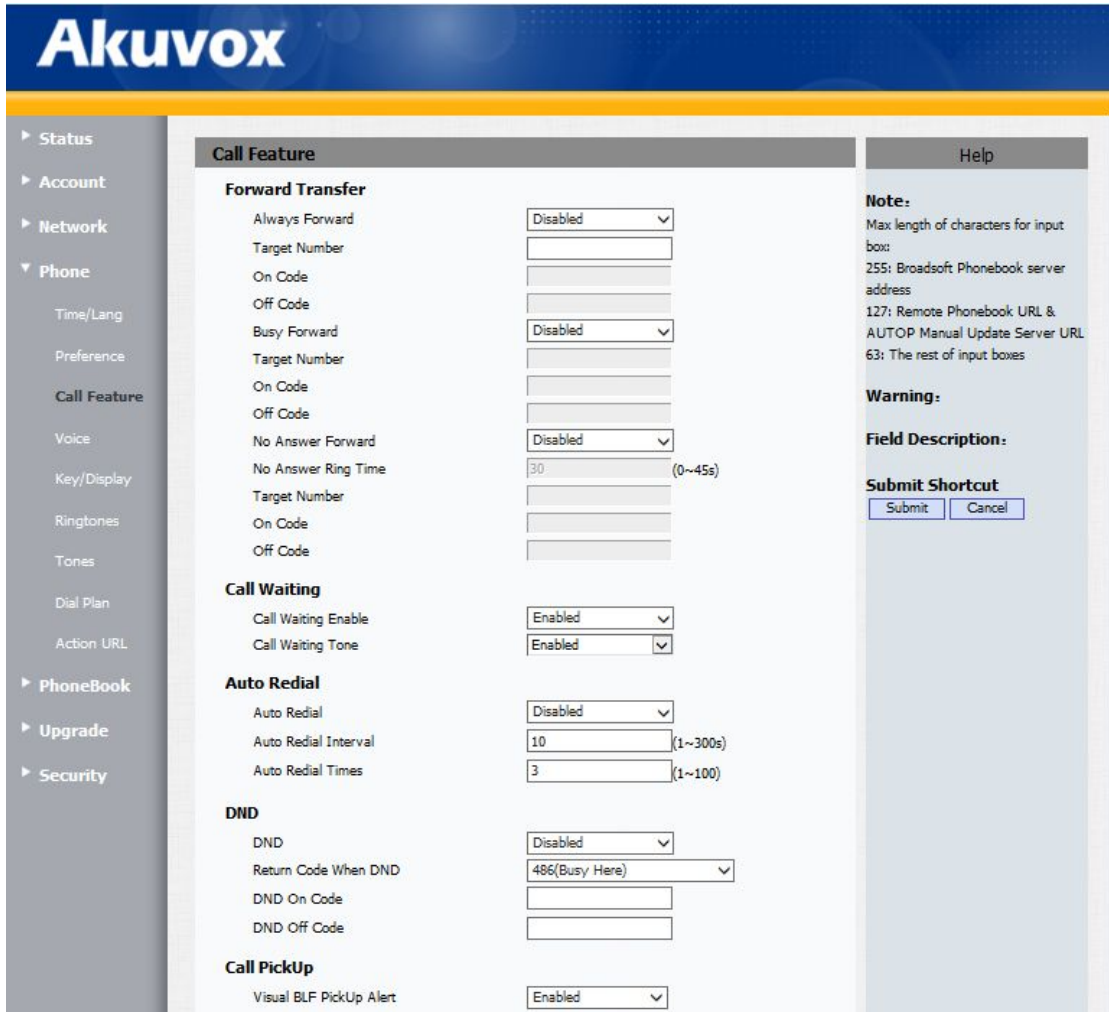

3. Click **Submit** to accept the change.

## Automatic Call Distribution

An automatic call distributor (ACD) in telephony is a system that distributes incoming calls to a specific group of terminals used by agents. It is a part of a computer telephony integration (CTI) system. ACDs recognize, answer and route incoming calls. They range from small systems maintaining a few lines up to systems maintaining a large number of lines for large applications.

ACD depends on support from a SIP server. ACD is disabled on the phone by default. You need to enable it on a per-line basis before logging into the ACD system

When an IP phone user logs into the ACD system, the server will monitor the phone status. When there is an incoming call, then ACD system will decide whether to assign an incoming call to the user's IP phone. When the phone status is changed to unavailable, the server stops distributing calls to the IP phone.

**Procedure**

ACD can be configured using the configuration files or locally.

<b>Configuration File</b>	<r000000000xx>.conf/<MAC>.conf	Assign an ACD key. Configure ACD auto available.
<b>Local</b>	Web User Interface	Assign an ACD key. Navigate to: http://<phoneIPAddress>/fcgi/do?id=4&id=4 Configure ACD auto available. Navigate to: http://<phoneIPAddress>/fcgi/do?id=4&id=2
	Phone User Interface	Assign an ACD key.

**To configure an ACD key via web user interface:**

1. Click on **Phone->Key/Display->DSS Key (or Line Key)**.
2. In the desired **DSS key** field, select ACD from the pull-down list of **Type**.

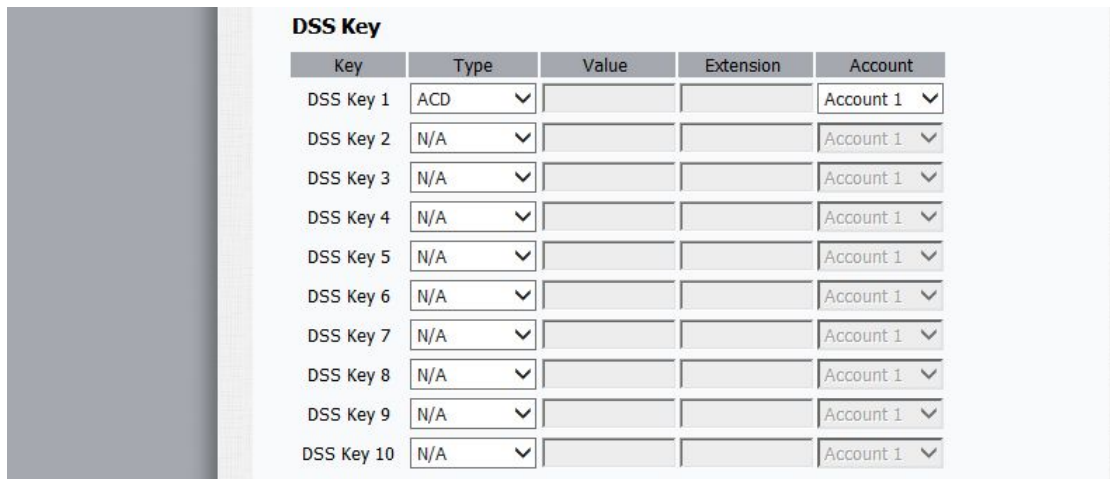

3. Click **Submit** to accept the change.

**To configure ACD auto available via web user interface:**

1. Click on **Phone > Call Features > ACD**.
2. Select the desired line from the pull-down list of **ACD Auto Available**.
3. Enter the desired time in **ACD Auto Available Timer (0~180s)** field.

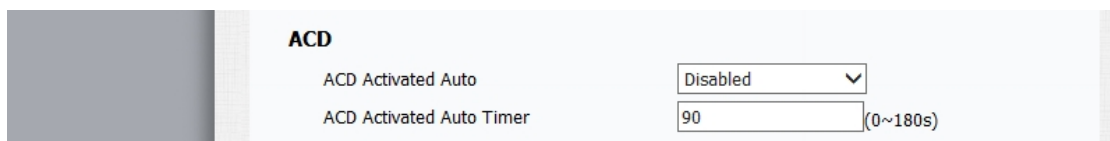

4. Click **Submit** to accept the change.

**To configure an ACD key via phone user interface:**

1. Press **Menu** > **Features** > **Programmable Keys** > **DSS Keys**
2. Select the desired DSS key.
3. Press **Up** and **Down** to select ACD from the **Type** field.
4. Press the **Save** soft key to accept the change.

## Message Waiting Indicator

Message Waiting Indicator is used to indicate whether there is unread new voice message. The IP phones support both audio and visual MWI when receiving new voice messages.

**Procedure**

Configuration changes can be performed using the configuration files or locally.

<b>Configuration File</b>	<r0000000000xx>.conf/ <MAC>.conf	Configure subscribe for MWI.
<b>Local</b>	Web User Interface	Configure subscribe for MWI. Navigate to: <a href="http://&lt;phoneIPAddress&gt;/fcgi/do?id=3&amp;id=2">http://&lt;phoneIPAddress&gt;/fcgi/do?id=3&amp;id=2</a>

**To configure subscribe for MWI via web user interface:**

1. Click on **Account**.
2. Select the desired account from the pull-down list of **Account**.
3. Click on **Advanced**.
4. Enable **MWI Subscribe** from the pull-down list.
5. Enter the period time in the **MWI Subscription Period** (Seconds) field.

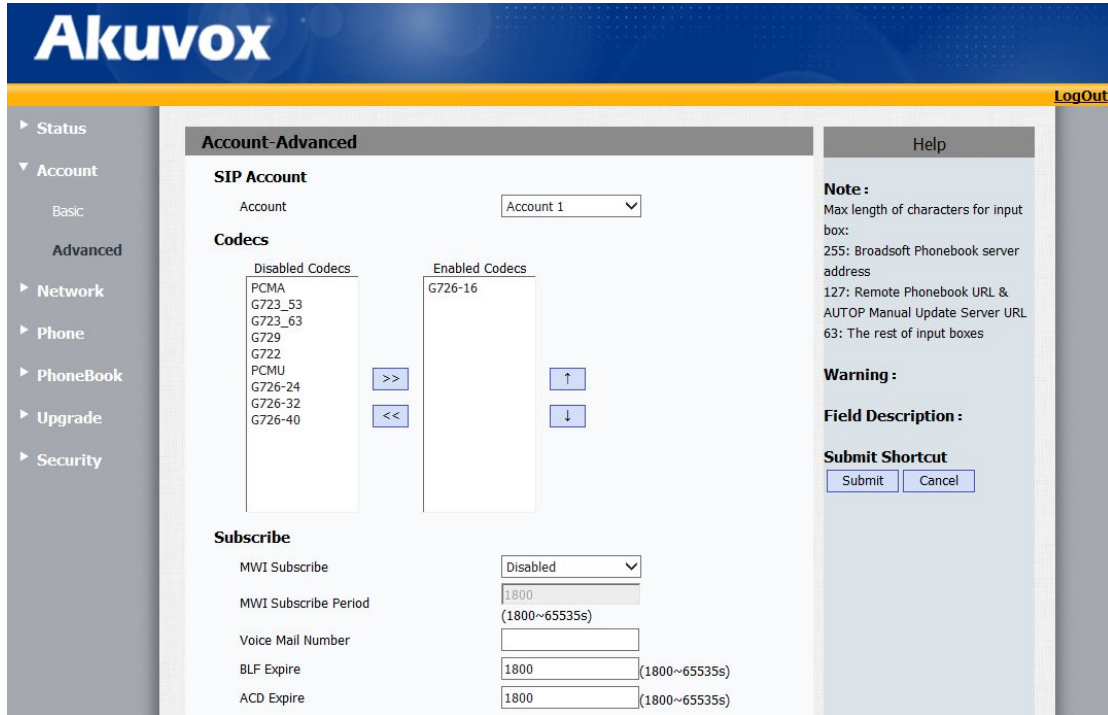

6. Click **Submit** to accept the change.

## Call Recording

Call recording is based on SIP server, and it allows users to record calls. When the user presses the call record key, recording is triggered and users can indicate the recording status. The recording will be finally stored on SIP server

When a user presses a record key for the first time during a call, the IP phone sends a SIP INFO message to the server with the specific header "Record: on", and then the recording starts.

Example of a SIP INFO message:

```
Via: SIP/2.0/UDP 192.168.10.2:5062;branch=z9hG4bK1524899995
From: "1004" <sip:1004@192.168.10.190>;tag=1636688805
To: <sip:1002@192.168.10.190>;tag=as50a608dd
Call-ID: 1709769182
CSeq: 22 INFO
Contact: <sip:1004@192.168.10.2:5062>
Authorization: Digest username="1004", realm="asterisk", nonce="6057fcca",
uri="sip:1002@192.168.10.190:5060", response="a2adc623d029bfce9cc200cbdf8ff752",
algorithm=MD5
Max-Forwards: 70
User-Agent: Akuvox 3240 59.138.2.23
```

Record: on  
Content-Length: 0

When the user presses the record key for the second time, the IP phone sends a SIP INFO message to the server with the specific header "Record: off", and then the recording stops.

Example of a SIP INFO message:

```
Via: SIP/2.0/UDP 192.168.10.5:5062;branch=z9hG4bK455692650
From: "1004" <sip:1004@192.168.10.190>;tag=496967067
To: <sip:1002@192.168.10.190>;tag=as71127aec
Call-ID: 1685023873
CSeq: 27 INFO
Contact: <sip:1004@192.168.10.5:5062>
Authorization: Digest username="1004", realm="asterisk", nonce="0dcefa2f",
uri="sip:1002@192.168.10.190:5060", response="5b143030217d4281f79b65543b792de7",
algorithm=MD5
Max-Forwards: 70
User-Agent: Akuvox 3240 59.138.2.23
Record: off
Content-Length: 0
```

**Procedure**

Call recording key can be configured using the configuration files or locally.

<b>Configuration File</b>	<r0000000000xx>.conf /<MAC>.conf	Assign a record key.
<b>Local</b>	Web User Interface	Assign a record key and URL record key. Navigate to: <a href="http://&lt;phoneIPAddress&gt;/cgi/do?id=4&amp;id=4">http://&lt;phoneIPAddress&gt;/cgi/do?id=4&amp;id=4</a>
	Phone User Interface	Assign a record key

**To configure Record key via web user interface:**

1. Click on **Phone > Key/Display > DSS Key (or Line Key)**.
2. In the desired DSS key field, select Record from the pull-down list of **Type**.

**Line Key**

Key	Type	Label	Value	Extension	Account
Line Key 1	Record	Record			Account 1
Line Key 2	Account				Account 2
Line Key 3	Account				Account 3
Line Key 4	Account				Account 4
Line Key 5	Account				Account 5
Line Key 6	Account				Account 6
Line Key 7	Account				Account 1

**DSS Key**

Key	Type	Value	Extension	Account
DSS Key 1	Record			Account 1
DSS Key 2	N/A			Account 1
DSS Key 3	N/A			Account 1
DSS Key 4	N/A			Account 1
DSS Key 5	N/A			Account 1
DSS Key 6	N/A			Account 1
DSS Key 7	N/A			Account 1
DSS Key 8	N/A			Account 1
DSS Key 9	N/A			Account 1
DSS Key 10	N/A			Account 1

3. Click **Submit** to accept the change.

## Hot Desking

In some working place, the people are always walking around. Hot desking feature will make the staffs login his account on any phones in the company. In some public places, the working people is not fixed, anyone can use Hot desking for logging his account, and setting the phones to the familiar mode, such as the remote function of the computer.

Hot desking allows a user to clear registration configurations of all accounts on the IP phone, and then register his account on line 1. In order to use this feature, you need to assign a hot desking key.

### Procedure

Hot desking key can be configured using the configuration files or locally.

<b>Configuration File</b>	<r000000000xx>.conf/ <MAC>.conf	Assign a hot desking key.
<b>Local</b>	Web User Interface	Assign a hot desking key. Navigate to: http://<phoneIPAddress>/cgi/do?id=4&id=4
	Phone User Interface	Assign a hot desking key.

(NOTE: DSS key function only can be supported on SP-R59P)

**To configure Hot Desking key via web user interface:**

1. Click on **Phone > Key/Display > DSS Key** (or **Line Key** or **Programable Key**).
2. In the desired **DSS key** field, select **Hot Desking** from the pull-down list of **Type**.

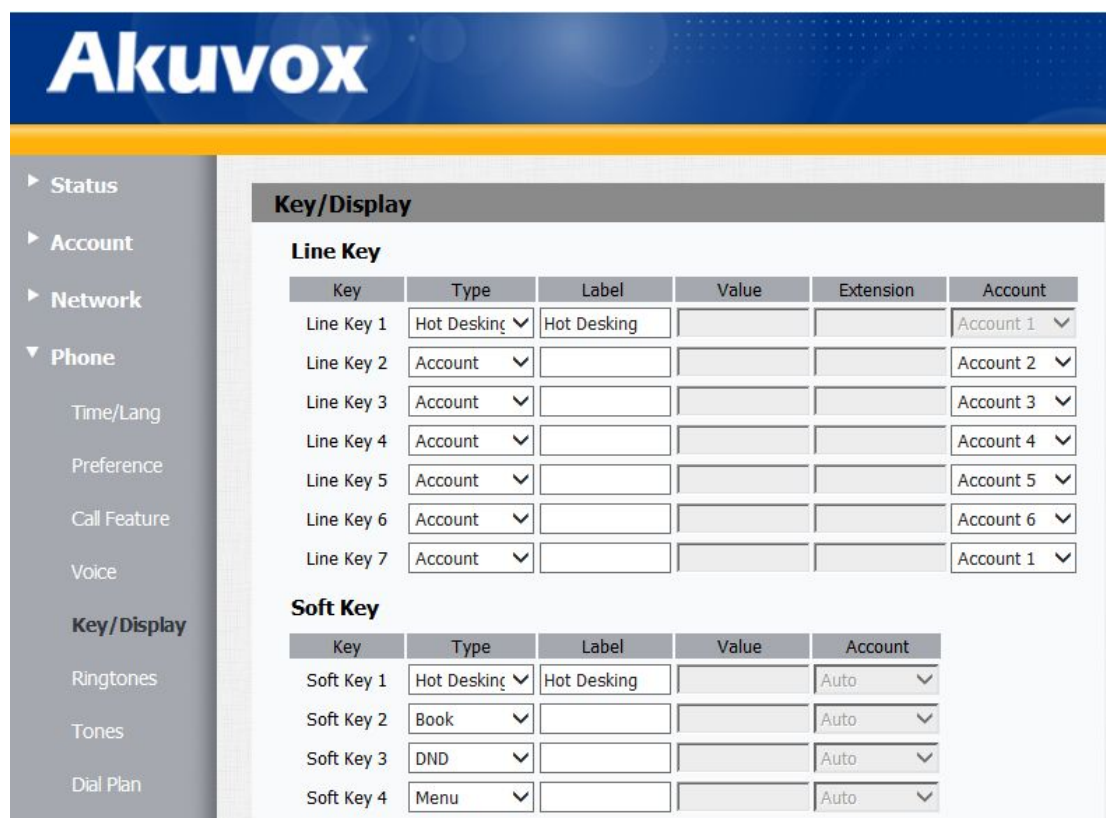

DSS Key				
Key	Type	Value	Extension	Account
DSS Key 1	Hot Desking			Account 1
DSS Key 2	N/A			Account 1
DSS Key 3	N/A			Account 1
DSS Key 4	N/A			Account 1
DSS Key 5	N/A			Account 1
DSS Key 6	N/A			Account 1
DSS Key 7	N/A			Account 1
DSS Key 8	N/A			Account 1
DSS Key 9	N/A			Account 1
DSS Key 10	N/A			Account 1

3. Click **Submit** to accept the change.

**To configure a hot desking DSS key via phone user interface:**

1. Press **Menu > Features > Programmable Keys > DSS Keys**.
2. Select the desired **DSS key**.
3. Press **Up** and **Down** to select **Hot Desking** from the **Key Type** field.
4. Press the **Save** soft key to accept the change.

## Action URL

Action URL allows IP phones to interact with web server applications. It sends out an HTTP or HTTPS GET request. When there is a specified event, you can specify a URL that triggers a GET request. The valid URL format is, for example,

`http://192.168.10.26/help.xml?model=$model;mac=$mac;ip=$ip;firmware=$firmware;active_url=$active_url;active_user=$active_user`

The following table lists the pre-defined events for action URL.

Event	Description
Setup Completed	When the IP phone completes startup.
Registered	When the IP phone successfully registers an account.
Unregistered	When the IP phone logs off the registered account.
Register Failed	When the IP phone fails to register an account.
Off Hook	When the IP phone is off hook.
On Hook	When the IP phone is on hook.
Incoming Call	When the IP phone receives an incoming call.



Outgoing Call	When the IP phone makes a outgoing call.
Established	When the IP phone establishes a call.
Terminated	When the IP phone terminates a call.
Open DND	When the IP phone terminates a call.
Close DND	When the IP phone disables the DND mode.
Open Always Forward	When the IP phone enables the always forward.
Close Always Forward	When the IP phone disables the always forward.
Open Busy Forward	When the IP phone enables the busy forward.
Close Busy Forward	When the IP phone disables the busy forward.
Open No Answer Forward	When the IP phone disables the busy forward.
Close No Answer Forward	When the IP phone disables the no answer forward.
Transfer Call	When the IP phone transfers a call.
Blind Transfer	When the IP phone blind transfers a call.
Attended Transfer	When the IP phone performs the semi-attended/attended transfer.
Hold	When the IP phone places a call on hold.
UnHold	When the IP phone retrieves a hold call.
Mute	When the IP phone mutes a call.
UnMute	When the IP phone un-mutes a call.
Missed Call	When the IP phone misses a call.
IP Changed	When the IP address of the IP phone changes.
Forward Incoming Call	When the IP phone forwards an incoming call.
Reject Incoming Call	When the IP phone rejects an incoming call.
Answer New-In Call	When the IP phone answers a new call.
Transfer Finished	When the IP phone completes to transfer a call.
Transfer Failed	When the IP phone fails to transfer a call.
Idle To Busy	When the state of the IP phone changes from idle to busy.
Busy To Idle	When the state of phone changes from busy to idle.

An HTTP or HTTPS GET request may contain variable name and variable value, separated by “=”. Each variable value starts with \$ in the query part of the URL. The valid URL format is: `http(s)://IP address of server/help.xml?variable name=$variable`.

Variable name can be customized by users, while the variable value is pre-defined. For example, a URL “`http://192.168.10.10/help.xml?mac=$mac`” is specified for the event Mute, \$mac will be dynamically replaced with the MAC address of the IP phone when the IP phone mutes a call.

The following table lists pre-defined variable values.

Variable Value	Description
\$mac	The MAC address of the IP phone
\$ip	The IP address of the IP phone
\$model	The IP phone model
\$firmware	The firmware version of the IP phone
\$active_url	The SIP URI of the current account
\$active_user	The user name for the current account
\$active_host	The host server for the current account
\$local	The sip name of the local side
\$remote	The sip name of the remote side
\$display_local	The display name of the local side
\$display_remote	The display name of the remote side
\$call_id	The call-id of the active call.

### Procedure

Action URL can be configured using the configuration files or locally.

<b>Configuration File</b>	<r0000000000xx>.conf/<MAC>.conf	Configure action URL.
<b>Local</b>	Web User Interface	Configure action URL. Navigate to: <a href="http://&lt;phoneIPAddress&gt;/fcgi/do?id=4&amp;id=10">http://&lt;phoneIPAddress&gt;/fcgi/do?id=4&amp;id=10</a>

### To configure action URL via web user interface:

1. Click on **Phone > Action URL**.
2. Enter the action **URLs** in the corresponding fields.

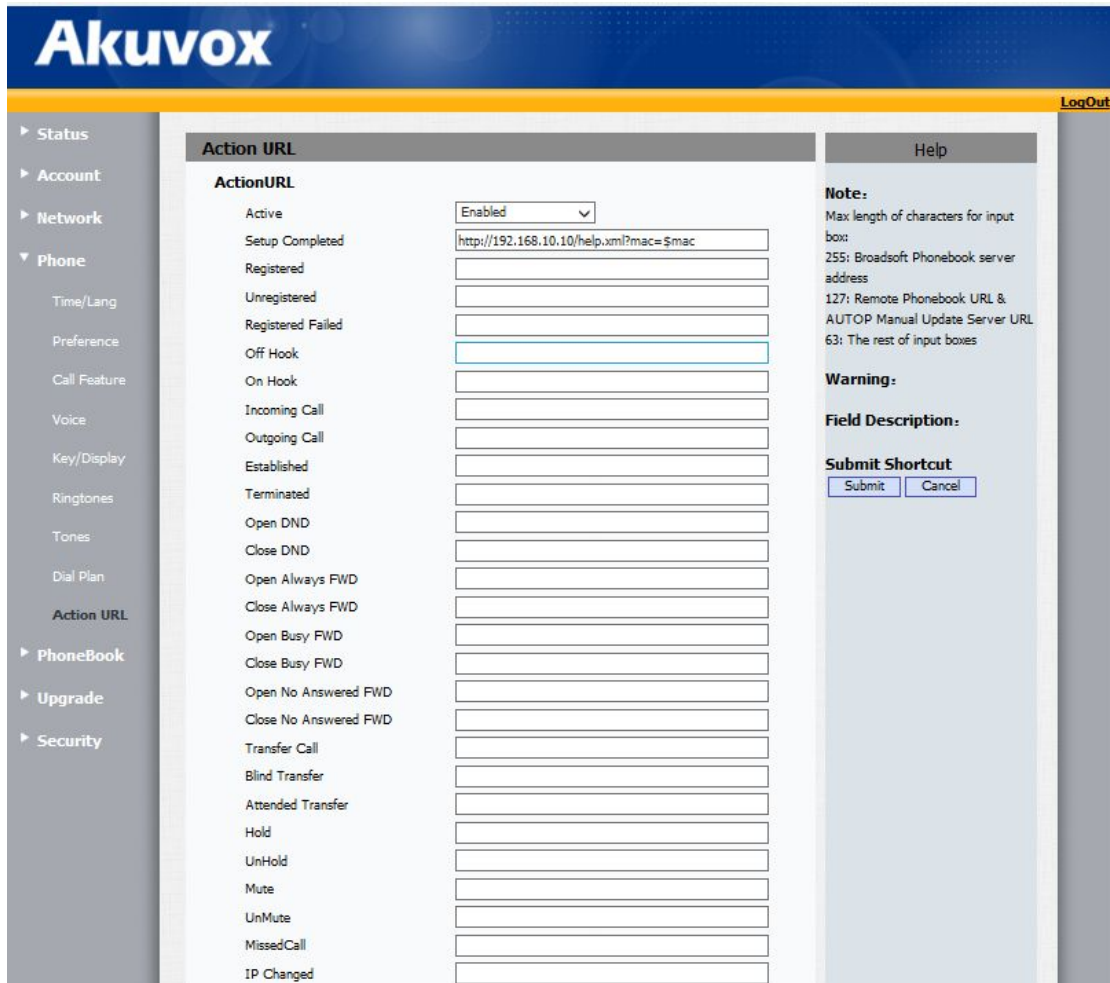

3. Click **Submit** to accept the change.

## Action URI

Action URI works the opposite way to action URL, action URI allows IP phones to interact with web server application by receiving and handling an HTTP or HTTPS GET request.

### Simple key press

The valid URI format is: `http(s)://phone IP address//fcgi/do?keydown=value`.

Variable Value	Phone Action
OK	Press the OK key
Cancel	Press the Cancel key
Speaker	Press the Speaker key.
Forward	Press the FWD key
VolumeUp	Increase the volume.
VolumeDown	Decrease the volume.
0-9 * /Pound	Press the keypad

L1 - LX	Press the line keys((Except for SP-R50P,for SP-R52P, X=2, for SP-R53, X=3, for SP-R59, X=6)
D1 –DX	Press the DSS key(only SP-R59P supports , X is max DSS Key number)
S1-S4	Press the soft keys
MSG	Press the MESSAGE key.
Headset	Press the HEADSET key.
RD	Press the RD key.
Up/Down/Left/Right	Press the navigation keys.
Hook	Press Hook key
Home	Press Home key
Mute	Press Mute key

### Perform a specific function

The valid URI format is: `http(s)://phone IP address/fcgi/do?action=value`

Variable Value	Phone Action
Reboot	Reboot the phone
AutoP	Perform Auto provisioning
DNDOn	Enable DND
DNDOff	Disable DND
MakeCall	Make a call**
CallEnd	Hang up the call
Reset	Restore the factory settings
Hold	Hold the call
UnHold	Retrieved the call
Conference	Press the conference soft key during the call
Transfer	Press the TRAN soft key during the call
Enter	Enter the next page
Back	Back to the last page

Note: Makecall\*\* is in special format, it needs to add the additional account and phonenumber.

`http(s)://phone IP address/fcgi/do?action=MakeCall&number=xxx&line=yyy`

*//xxx means the called number, yyy means the username; //*

Or

`http(s)://phone IP address/fcgi/do?action=MakeCall&number=xxx&lineID=X,`

*//xxx means the called number, X is the linekey number, x=0,1,2,3...0 means AUTO.//*

For security reasons, IP phones do not receive and handle HTTP/HTTPS GET requests by default.

You need to specify the trusted IP address for action URI. You can specify one or more trusted IP addresses on the IP phone, or configure the IP phone to receive and handle the URI from any IP address.

**Procedure**

Specify the trusted IP address for action URI using the configuration files or locally.

<b>Configuration File</b>	<r0000000000xx>.conf/<MAC>.conf	Specify the trusted IP address(es) for sending the action URI to the IP phone.
<b>Local</b>	Web User Interface	Specify the trusted IP address(es) for sending the action URI to the IP phone.  Navigate to: http://<phoneIPAddress>/fcgi/do?id=4&id=2

**To configure the trusted IP address(es) for action URI via web user interface:**

1. Click on **Phone > Call Features > Remote Control**.

2. Enter the IP address or any in the **Action URI allow IP List** field.

//Multiple IP addresses are separated by commas. And you can use the letter x or X to instead any IP address number, for example: 192.168.xx.xx, it means the remote control ip address is 192.168.10~99.10~99//

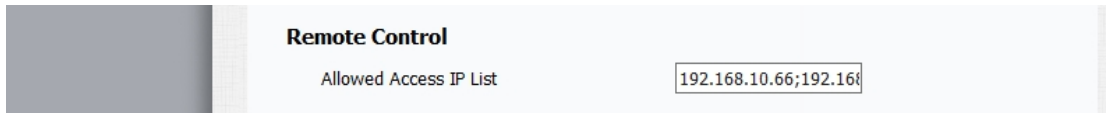

3. Click **Submit** to accept the change.

## SIP and Akuvox IP Phones

Akuvox IP phones use Session Initiation Protocol (SIP), allowing interoperation with all IT service providers supporting SIP.

SIP handles signaling and session management within a packet telephony network. Signaling allows call information to be carried across network boundaries. Session management controls the attributes of an end-to-end call.

The diagram shows a SIP request for connection to another subscriber in the network.

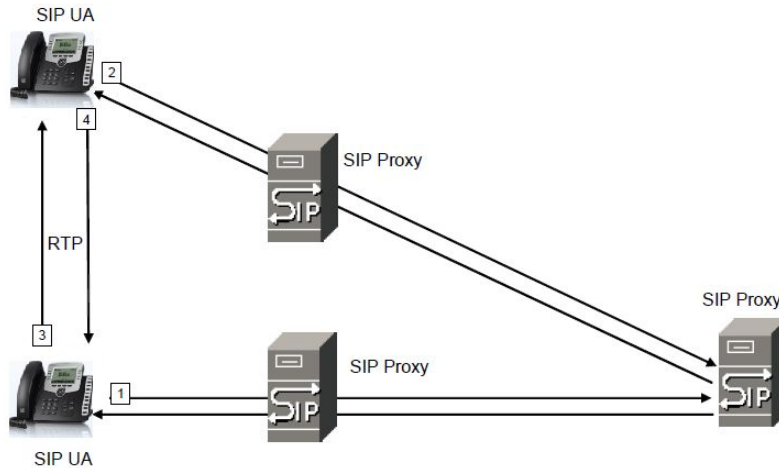

In typical commercial IP telephony deployments, all calls go through a SIP proxy server. The requesting phone is called the SIP user agent server (UAS), while the receiving phone is called the user agent client (UAC).

SIP message routing is dynamic. If a SIP proxy receives a request from a UAS for a connection but cannot locate the UAC, the proxy forwards the message to another SIP proxy in the network. When the UAC is located, the response is routed back to the UAS, and a direct peer-to-peer session is established between the two UAs. Voice traffic is transmitted between UAs over dynamically-assigned ports using Real-time Protocol (RTP).

RTP transmits real-time data such as audio and video; it does not guarantee realtime delivery of data. RTP provides mechanisms for the sending and receiving applications to support streaming data. Typically, RTP runs on top of UDP.

### Server redundancy

Server redundancy is often required in VoIP deployments to ensure continuity of phone service, for events where the server needs to be taken offline and the connect fails.

Two types of redundancy are possible. In some cases, a combination of the two may be deployed:

- **Failover:** In this mode, the full phone system functionality is preserved by having a second equivalent capability call server take over from the one that has gone down/off-line. This mode of operation should be done using the DNS mechanism from the primary to the secondary server.
- **Fallback:** In this mode, a second less featured call server with SIP capability takes over call control to provide basic calling capability, but without some advanced features offered by the working server (for example, shared line, call recording and MWI). IP phones support configuration of two SIP servers per SIP registration for fallback purpose.

## Phone Registration

Registration methods of the fallback mode include:

- **Concurrent registration:** The IP phone registers to two SIP servers (working server and fallback server) at the same time. In a failure situation, a fallback server can take over the basic calling capability, but without some of the advanced features offered by the working server (default registration method).
- **Successive registration:** The IP phone only registers to one server at a time. The IP phone first registers to the working server. In a failure situation, the IP phone registers to the fallback server.

When registering to the working server, the IP phone must always register to the primary server first except in failover conditions. When the primary server registration is unavailable, the secondary server will serve as the working server.

Server redundancy can be configured using the configuration files or locally.

<b>Configuration File</b>	<r000000000xx>.conf/ <MAC>.conf	Configure the server on the IP phone. For more information
<b>Local</b>	Web User Interface	Configure the server on the IP phone. Navigate to: <a href="http://&lt;phoneIPAddress&gt;/fcgi/do?id=3&amp;id=1">http://&lt;phoneIPAddress&gt;/fcgi/do?id=3&amp;id=1</a>

### To configure server redundancy for fallback purpose via web user interface:

1. Click on **Account > Basic**.
2. Select the desired account from the pull-down list of **Account**.
3. Configure registration parameters of the selected account in the corresponding fields.
4. Select the desired value from the pull-down list of **Transport**.
5. Configure parameters of **SIP server 1** and **SIP server 2** in the corresponding fields.

6. Click **Submit** to accept the change.

### SIP Server Domain Name Resolution

If a domain name is configured for a SIP server, the IP address(es) associated with that domain name will be resolved through DNS as specified. The DNS query involves SRV, which allows the IP phone to adapt to various deployment environments.

If an explicit port (except 0) is specified and the transport type is set to DNS-SRV, A query will be performed only. If a SIP server port is set to 0 and the transport type is set to DNS-NAPTR, NAPTR and SRV queries will be tried before falling to A query. If no port is found through the DNS query, 5060 will be used.

The following details the procedures of DNS query for the IP phone to resolve the domain name (e.g., akuvox.pbx.com) of working server into the IP address, port and transport protocol.

#### SRV (Service Location Record)

The IP phone performs an SRV query on the record returned from the NAPTR for the host name and the port number. Example of SRV records:

```
Priority Weight Port Target
IN SRV 0 1 5060 server1.akuvox.pbx.com
IN SRV 0 2 5060 server2.akuvox.pbx.com
```

Parameters are explained in the following table:



Parameter	Description
Priority	Specify preferential treatment for the specific host entry. Lower priority is more preferred.
Weight	When priorities are equal, weight is used to differentiate the preference. The preference is from highest to lowest. Keep the same to load balance.
Port	Identify the port number to be used.
Target	Identify the actual host for an A query.

SRV query returns two records. The two SRV records point to different hosts and have the same priority 0. The weight of the second record is higher than the first one, so the second record will be picked first. The two records also contain a port "5060", the IP phone uses this port. If the Target is not a numeric IP address, the IP phone performs an A query. So in this case, the IP phone uses "server1.akuvox.pbx.com" and "server2.akuvox.pbx.com" for the A query.

**Outgoing Call When the Working Server Connection Fails**

When a user initiates a call, the phone will go through the following steps to connect the call:

1. Sends the INVITE request to the primary server.
2. If the primary server does not respond correctly to the INVITE, then tries to make the call using the secondary server.
3. If the secondary server is also unavailable, the IP phone will try the fallback server until it either succeeds in making a call or exhausts all servers at which point the call will fail.

At the start of a call, server availability is determined by SIP signaling failure. SIP signaling failure depends on the SIP protocol being used as described below:

- If TCP is used, then the signaling fails if the connection or the send fails.
- If UDP is used, then the signaling fails if ICMP is detected or if the signal times out. If the signaling has been attempted through all servers in the list and this is the last server, then the signaling fails after the complete UDP timeout defined in RFC 3261.

If it is not the last server in the list, the maximum number of retries depends on the configured retry count.

**Procedure**

Server redundancy can be configured using the configuration files or locally.

<b>Configuration File</b>	<r0000000000xx>.conf/ <MAC>.conf	Configure the transport type on the IP phone. For more information.
---------------------------	-------------------------------------	--

<b>Local</b>	Web User Interface	Configure the transport type on the IP phone. Navigate to: <a href="http://&lt;phoneIPAddress&gt;/fcgi/do?id=3&amp;id=1">http://&lt;phoneIPAddress&gt;/fcgi/do?id=3&amp;id=1</a>
--------------	--------------------	--

## LLDP

LLDP (Linker Layer Discovery Protocol) is a vendor-neutral Link Layer protocol, in the Internet Protocol Suite used by network devices for advertising their identity, capabilities, and neighbors on an IEEE 802 local area network, principally wired Ethernet

### Procedure

LLDP can be configured using the configuration files or locally.

<b>Configuration File</b>	<r0000000000xx>.conf/ <MAC>.conf	Configure the LLDP .
<b>Local</b>	Web User Interface	Configure LLDP. Navigate to: <a href="http://&lt;phoneIPAddress&gt;/fcgi/do?id=2&amp;id=2">http://&lt;phoneIPAddress&gt;/fcgi/do?id=2&amp;id=2</a>

### To configure LLDP via web user interface:

1. Click on **Network > Advanced**.
2. In the **LLDP** block, select the desired value from the pull-down list of **Active**.
3. Enter the desired time interval in the **Packet Interval** (10~3600s) field.

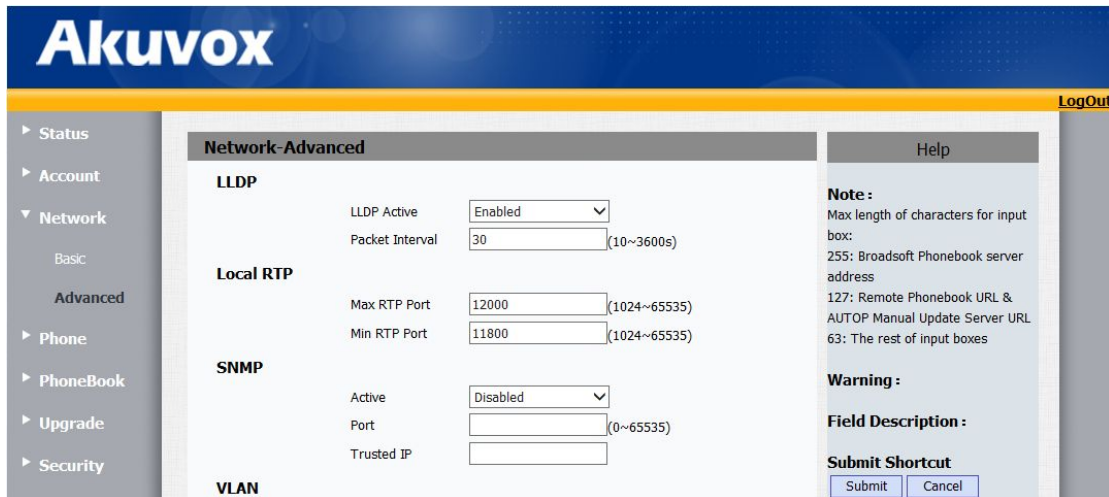

4. Click **Submit** to accept the change.

A dialog box pops up to prompt that settings will take effect after a reboot.

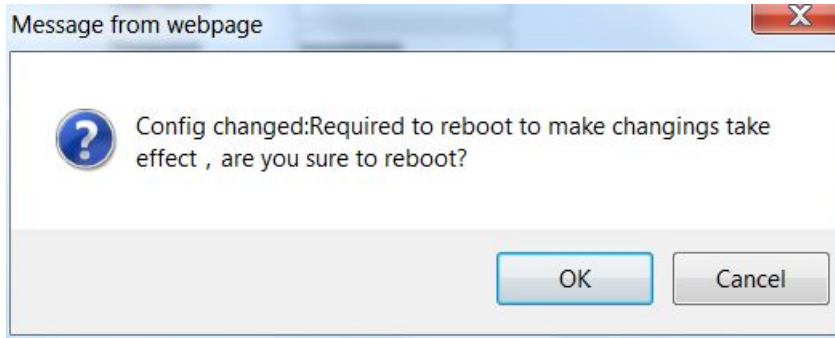

5. Click **OK** to reboot the IP phone.

## VLAN

VLAN is short for virtual LAN, a network of devices that behave as if they are connected to the same wire even though they may actually be physically located on different segments of a LAN. VLANs are configured through software rather than hardware, which makes them extremely flexible. One of the biggest advantages of VLANs is that when a device is physically moved to another location, it can stay on the same VLAN without any hardware reconfiguration

The purpose of VLAN configurations on the IP phone is to insert tag with VLAN information to the packets generated by the IP phone. When VLAN is properly configured for the ports (Internet port and PC port) on the IP phone, the IP phone will tag all packets from these ports with the VLAN ID. The switch receives and forwards the tagged packets to the corresponding VLAN according to the VLAN ID in the tag as described in IEEE Std 802.3.

### Procedure

VLAN can be configured using the configuration files or locally.

#### Configuration File

<b>Configuration File</b>	<r0000000000xx>.conf/ <MAC>.conf	Configure VLAN for the LAN port and PC port manually.
<b>Local</b>	Web User Interface	Configure VLAN for the LAN port and PC port. Navigate to: <a href="http://&lt;phoneIPAddress&gt;/fcgi/do?id=2&amp;id=2">http://&lt;phoneIPAddress&gt;/fcgi/do?id=2&amp;id=2</a>
	Phone User Interface	Configure VLAN for the LAN port and PC port.

#### To configure VLAN for Internet port via web user interface:

1. Click on **Network > Advanced**.
2. In the **VLAN** block, select the desired value from the pull-down list of **LAN Port Active**.

3. Enter the VLAN ID in the **VID (1-4094)** field.
4. Select the desired value (0-7) from the pull-down list of **Priority**.

5. Click **Submit** to accept the change.  
A dialog box pops up to prompt that the settings will take effect after a reboot.

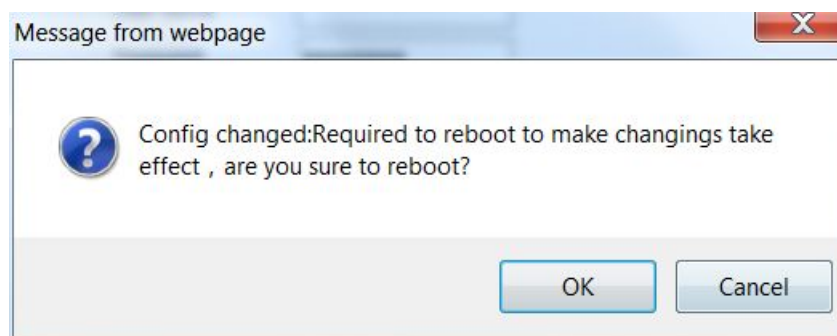

6. Click **OK** to reboot the IP phone.

#### To configure VLAN for PC port via web user interface:

1. Click on **Network > Advanced**.
2. In the **VLAN** block, select the desired value from the pull-down list of **PC Port Active**.
3. Enter the VLAN ID in the **VID (1-4094)** field.
4. Select the desired value (0-7) from the pull-down list of **Priority**.

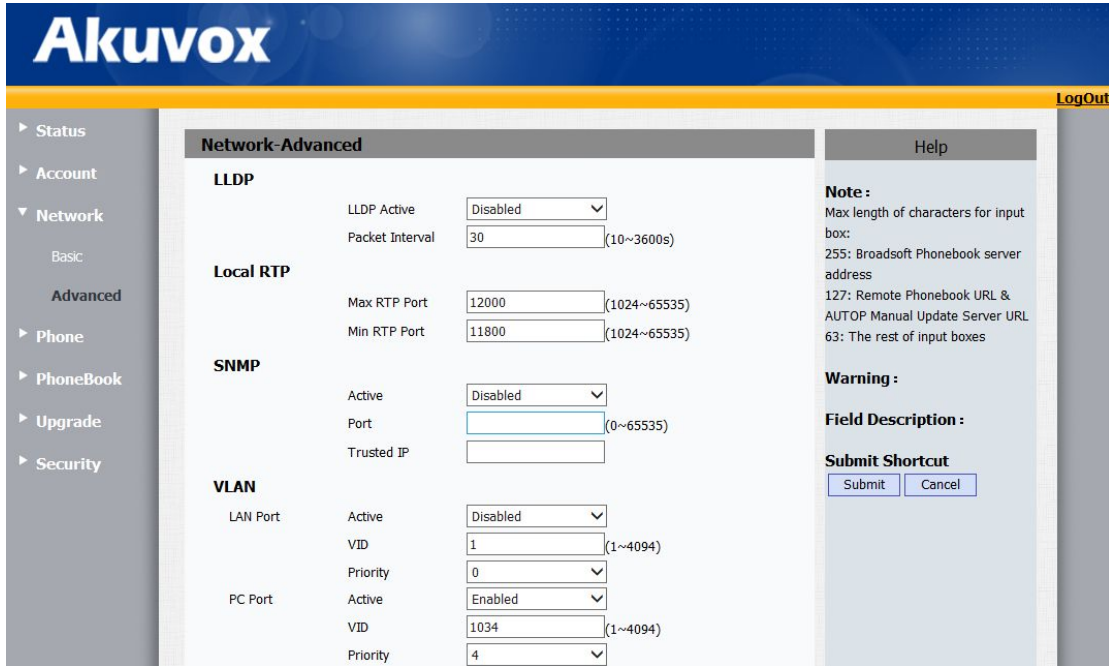

5. Click **Submit** to accept the change.

A dialog box pops up to prompt that the settings will take effect after a reboot.

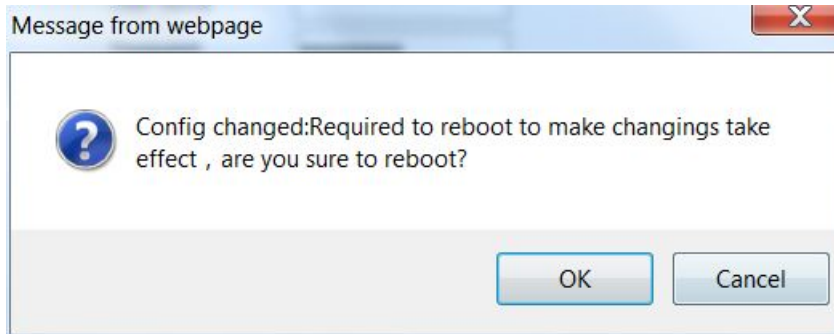

6. Click **OK** to reboot the IP phone.

**To configure VLAN for Internet port (or PC port) via phone user interface:**

1. Press **Menu** > **Settings** > **Advanced Settings** (password: admin) > **Network**> **VLAN** > **LAN Port** (or **PC Port**).
2. Press **Up** or **Down** to select the desired value from the **VLAN Status** field.
3. Enter the VLAN ID (1-4094) in the **VID Number** field.
4. Enter the priority value (0-7) in the **Priority** field.
5. Press the **Save** to accept the change

The IP phone reboots automatically to make settings effective after a period of time.

## VPN

A virtual private network (VPN) extends a private network across a public network, such as the Internet. It enables a computer to send and receive data across shared or public networks as if it is directly connected to the private network, while benefiting from the functionality, security and management policies of the private network. A VPN is created by establishing a virtual point-to-point connection through the use of dedicated connections, virtual tunneling protocols, or traffic encryptions.

IP phones support SSL VPN, which provides remote-access VPN capabilities through SSL. In order to use VPN, the compressed package of VPN-related files should be uploaded to the IP phone. The file format of the compressed package must be \*.tar. For IP phones, the maximum file size is 50KB. The related VPN files are: certificates (ca.crt and client.crt), key (client.key) and the configuration file (vpn.cnf) of the VPN client.

### Procedure

VPN can be configured using the configuration files or locally.

<b>Configuration File</b>	<r0000000000xx>.conf/ <MAC>.conf	Configure VPN feature and upload a TAR file to the IP phone.
<b>Local</b>	Web User Interface	Configure VPN feature and upload a TAR package to the IP phone.  Navigate to: http://<phoneIPAddress>/fcgi/do?id=2&id=2
	Phone User Interface	Configure VPN feature.

### To upload a TAR file and configure VPN via web user interface:

1. Click on **Network > Advanced**.
2. Click **Browse** to locate the TAR file from the local system.
3. Click **Upload** to upload the TAR file.

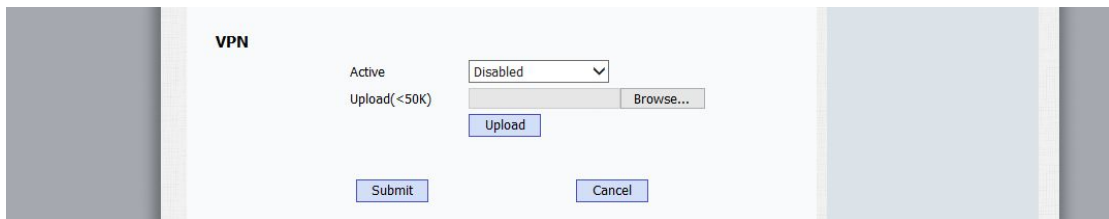

The web user interface prompts the message “Import config...”.

4. In the **VPN** block, select the desired value from the pull-down list of **Active**.
5. Click **Submit** to accept the change.

A dialog box pops up to prompt that settings will take effect after a reboot.

6. Click **OK** to reboot the IP phone.

**To configure VPN via phone user interface after uploading a TAR file:**

1. Press **Menu > Settings > Advanced Settings** (password: admin) > **Network > VPN**.

2. Press **Up** or **Down** to select the desired value from the **VPN Active** field.

You must upload the OpenVPN TAR file using configuration files or via web user interface in advance.

3. Press the **Save** to accept the change.

The IP phone reboots automatically to make settings effective after a period of time.

## Quality of Service

Quality of service (QoS) is the overall performance of a telephony network, particularly the performance seen by the users of the network. To quantitatively measure quality of service, several related aspects of the network service are often considered, such as error rates, bandwidth, throughput, transmission delay, availability, jitter, etc.

QoS provides better network service through the following features:

- Supporting dedicated bandwidth
- Improving loss characteristics
- Avoiding and managing network congestion
- Shaping network traffic
- Setting traffic priorities across the network

The Best-Effort service is the default QoS model in IP networks. It provides no guarantees for data delivering, which means delay, jitter, packet loss and bandwidth allocation are unpredictable. Differentiated Services (DiffServ or DS) is the most widely used QoS model. It provides a simple and scalable mechanism for classifying and managing network traffic and providing QoS on modern IP networks. Differentiated Services Code Point (DSCP) is used to define DiffServ classes and stored in the first six bits of the ToS (Type of Service) field. Each router on the network can provide QoS simply based on the DiffServ class. The DSCP value ranges from 0 to 63 with each DSCP specifying a particular per-hop behavior (PHB) applicable to a packet. A PHB refers to the packet scheduling, queuing, policing, or shaping behavior of a node on any given packet.

Four standard PHBs available to construct a DiffServ-enabled network and achieve

**QoS:**

- Class Selector PHB -- backwards compatible with IP precedence. Class Selector code points are of the form "xxx000". The first three bits are the IP precedence bits. These class selector PHBs retain almost the same forwarding behavior as nodes that implement IP precedence-based classification and forwarding.
- Expedited Forwarding PHB -- the key ingredient in DiffServ model for providing a low-loss, low-latency, low-jitter and assured bandwidth service.
- Assured Forwarding PHB -- defines a method by which BAs (Bandwidth Allocations) can be given different forwarding assurances.
- Default PHB -- specifies that a packet marked with a DSCP value of "000000" gets the traditional best effort service from a DS-compliant node.

VoIP is extremely bandwidth and delay-sensitive. QoS is a major issue in VoIP implementations, regarding how to guarantee that packet traffic not be delayed or dropped due to interference from other lower priority traffic. VoIP can guarantee high-quality QoS only if the voice and the SIP packets are given priority over other kinds of network traffic. IP phones support the DiffServ model of QoS.

**Voice QoS**

In order to make VoIP transmissions intelligible to receivers, voice packets should not be dropped, excessively delayed, or made to suffer varying delay. DiffServ model can guarantee high-quality voice transmission when the voice packets are configured to a higher DSCP value.

**SIP QoS**

SIP protocol is used for creating, modifying and terminating two-party or multi-party sessions. To ensure good voice quality, SIP packets emanated from IP phones should be configured with a high transmission priority.

DSCPs for voice and SIP packets can be specified respectively.

**Procedure**

QoS can be configured using the configuration files or locally.

<b>Configuration File</b>	<r0000000000xx>.conf/ <MAC>.conf	Configure the DSCPs for voice packets and SIP packets.
<b>Local</b>	Web User Interface	Configure the DSCPs for voice packets and SIP packets. Navigate to: <a href="http://&lt;phoneIPAddress&gt;/fcgi/do?id=2&amp;id=2">http://&lt;phoneIPAddress&gt;/fcgi/do?id=2&amp;id=2</a>



**To configure DSCPs for voice packets and SIP packets via web user interface:**

1. Click on **Network > Advanced**.
2. Enter the desired value in the **Voice QoS (0~63)** field.
3. Enter the desired value in the **SIP QoS (0~63)** field.

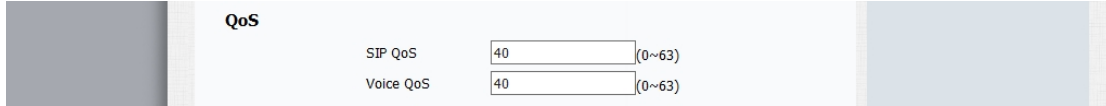

4. Click **Submit** to accept the change.
- A dialog box pops up to prompt that settings will take effect after a reboot.

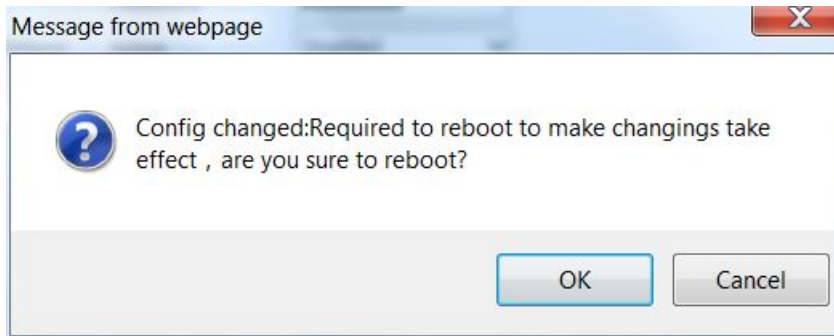

5. Click **OK** to reboot the IP phone.

## Network Address Translation

Network address translation (NAT) is a methodology of modifying network address information in Internet Protocol (IP) datagram packet headers while they are in transit across a traffic routing device for the purpose of remapping one IP address space into another.

### NAT Traversal

NAT Traversal is a general term for techniques that establish and maintain Internet protocol connections traversing network address translation (NAT) gateways, which break end-to-end connectivity. Intercepting and modifying traffic can only be performed transparently in the absence of secure encryption and authentication

### STUN (Simple Traversal of UDP over NATs)

STUN (Session Traversal Utilities for NAT) is a standardized set of methods and a network protocol to allow an end host to discover its public IP address if it is located behind a NAT. It is used to permit NAT traversal for applications of real-time voice, video, messaging, and other interactive IP communications.

### Procedure

NAT traversal and STUN server can be configured using the configuration files or locally.

<b>Configuration File</b>	<r0000000000xx>.conf/	Configure NAT traversal and STUN server on the
---------------------------	-----------------------	--

	<MAC>.conf	IP phone.
<b>Local</b>	Web User Interface	Configure NAT traversal and STUN server on the IP phone. Navigate to: <a href="http://&lt;phoneIPAddress&gt;/fcgi/do?id=3&amp;id=1">http://&lt;phoneIPAddress&gt;/fcgi/do?id=3&amp;id=1</a>

**To configure NAT traversal and STUN server via web user interface:**

1. Click on **Account > Basic**.
2. Select the desired account from the pull-down list of **Account**.
3. Select STUN from the pull-down list of **NAT**.

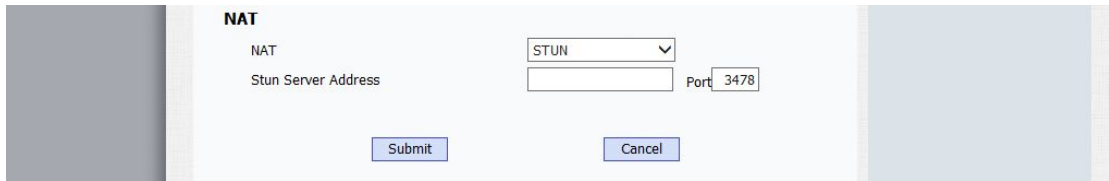

4. Enter the IP address or the domain name of the STUN server in the **STUN Server** field.
5. Click **Submit** to accept the change.

## 802.1X

IEEE 802.1X authentication is an IEEE standard for Port-based Network Access Control (PNAC), part of the IEEE 802.1 group of networking protocols. It offers an authentication mechanism for devices to connect/link to a LAN or WLAN. 802.1X authentication involves three parties: a supplicant, an authenticator, and an authentication server. The supplicant is a client device (such as a laptop) that wishes to attach to the LAN/WLAN - though the term 'supplicant' is also used interchangeably to refer to the software running on the client that provides credentials to the authenticator.

IP phones support protocols EAP-MD5, EAP-TLS, PEAP-MSCHAPv2 and EAP-TTLS/EAP-MSCHAPv2 for 802.1X authentication.

**Procedure**

802.1X authentication can be configured using the configuration files or locally.

<b>Configuration File</b>	<r0000000000xx>.conf/<MAC>.conf	Configure the 802.1X.
<b>Local</b>	Web User Interface	Configure the 802.1X. Navigate to: <a href="http://&lt;phoneIPAddress&gt;/fcgi/do?id=2&amp;id=2">http://&lt;phoneIPAddress&gt;/fcgi/do?id=2&amp;id=2</a>

**To configure the 802.1X authentication via web user interface:**

1. Click on **Network > Advanced**.
2. In the 802.1x block, select the desired protocol **EAP-MD5** from the pull-down list of **802.1x Mode**.
3. Enter the user name for authentication in the **Identity** field.
4. Enter the password for authentication in the **MD5 Password** field.

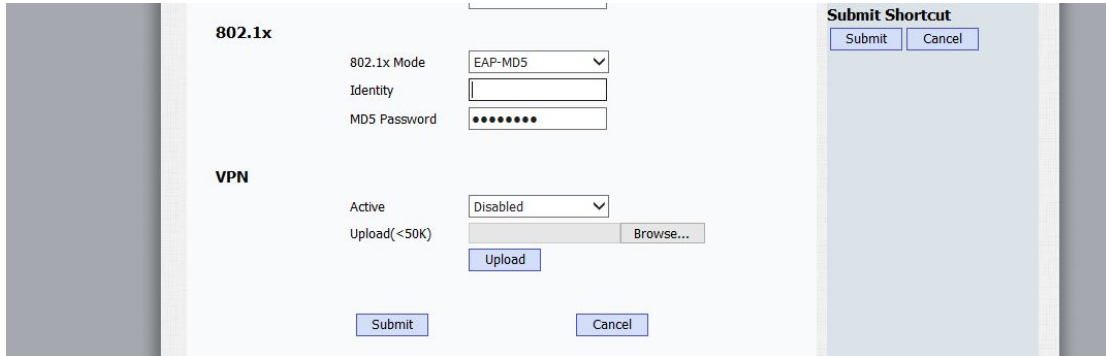

5. Click **Submit** to accept the change.
- A dialog box pops up to prompt that settings will take effect after a reboot.

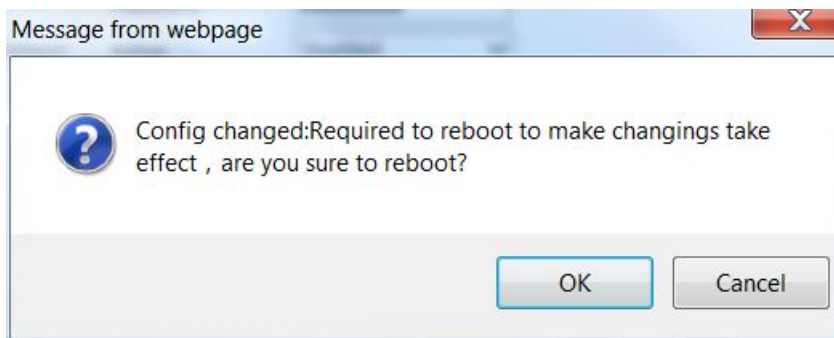

5. Click **OK** to reboot the IP phone.

## TR069 Device Management

TR-069 (Technical Report 069) is a Broadband Forum (formerly known as DSL Forum) technical specification entitled CPE WAN Management Protocol (CWMP). It defines an application layer protocol for remote management of end-user devices. As a bidirectional SOAP/HTTP-based protocol, it provides the communication between customer-premises equipment (CPE) and Auto Configuration Servers (ACS). It includes both a safe auto configuration and the control of other CPE management functions within an integrated framework.

TR-069 is intended to support a variety of functionalities to manage a collection of CPEs, including the following primary capabilities:

- Auto-configuration and dynamic service provisioning
- Software or firmware image management
- Status and performance monitoring

- Diagnostics

**Procedure**

TR-069 can be configured using the configuration files or locally.

<b>Configuration File</b>	<r0000000000xx>.conf/ <MAC>.conf	Configure TR-069 feature.
<b>Local</b>	Web User Interface	Configure TR-069 feature. Navigate to: http://<phoneIPAddress>/fcgi/do?id=2&id=2

**To configure TR-069 via web user interface:**

1. Click on **Settings > TR069**.
2. Select Enabled from the pull-down list of **Enable TR069**.
3. Enter the URL of the ACS in the **ACS URL** field.
4. Enter the user name and password authenticated by the ACS in the **ACS Username** and **ACS Password** fields.
5. Select the desired value from the pull-down list of **Enable Periodic Inform**.
6. Enter the desired time in the **Periodic Inform Interval (seconds)** field.
7. Enter the user name and password authenticated by the IP phone in the **Connection Request Username** and **Connection Request Password** fields.

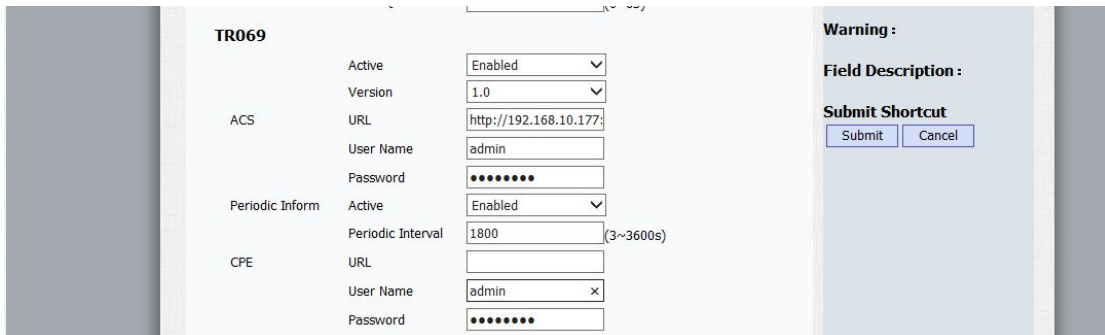

8. Click **Submit** to accept the change.

The description for TR069 web configuration:

Setting name	Valid values	Default	Description
ACS URL	String	empty	URL of the TR-069 ACS. This is the URL the phone will send TR-069 messages to. Please contact your ACS vendor to find out about this URL.
ACS Username	String	empty	Username for HTTP authentication against the ACS
ACS Password	String	empty	Password for HTTP authentication against the

			ACS
Enable Periodic Inform	Boolean	disable	Turn TR-069 Periodic Inform on and off.
Enable TR069	Boolean	disable	Turn TR-069 management on and off.
CPE URL	String	default	URL of the Device. This is the URL the TR-069 ACS will manage.
CPE User name	String	empty	Username to authenticate incoming connection requests.
CPE Password	String	empty	Password to authenticate incoming connection requests.

## Configuring Audio Features

This chapter provides information for making configuration changes for the following audio features:

- [Audio Codecs](#)
- [Acoustic Clarity Technology](#)

### Audio Codecs

CODEC is an abbreviation of COmpress-DECompress, capable of coding or decoding a digital data stream or signal by implementing an algorithm. The object of the algorithm is to represent the high-fidelity audio signal with minimum number of bits while retaining the quality. This can effectively reduce the frame size and the bandwidth required for audio transmission.

The default codecs used on IP phones are summarized in the following table:

Codec	Algorithm	Bit Rate	Sample Rate	Packetization Time
PCMA	G.711 a-law	64 Kbps	8 Ksps	20ms
PCMU	G.711 u-law	64 Kbps	8 Ksps	20ms
G729	G.729	8 Kbps	8 Ksps	20ms
G722	G.722	64 Kbps	16 Ksps	20ms

In addition to the codecs introduced above, IP phones also support codecs: G723\_53, G723\_63, G726-16, G726-24, G726-32, G726-40 (Codecs G726-16, G726-24 and G726-40 are not applicable to SP-R50P IP phones). Codecs and priorities of these codecs are configurable on a per-line basis. The attribute "rtpmap" is used to define a mapping from RTP payload codes to a codec, clock rate and other encoding parameters.

The corresponding attributes of the codec are listed as follows:

Codec	Configuration Methods	Priority	Ptime
PCMU	Configuration Files Web User Interface	1	20~30
PCMA	Configuration Files Web User Interface	2	20~30
G729	Configuration Files Web User Interface	3	20~80
G722	Configuration Files Web User Interface	4	20~30
G723_53	Configuration Files Web User Interface	0	30~60
G723_63	Configuration Files Web User Interface	0	30~60
G726-16	Configuration Files Web User Interface	0	20~30
G726-24	Configuration Files Web User Interface	0	20~30
G726-32	Configuration Files Web User Interface	0	20~30
G726-40	Configuration Files Web User Interface	0	20~30

#### Packetization Time





Ptime (Packetization Time) is a measurement of the duration (in milliseconds) of the audio data in each RTP packet sent to the destination, and defines how much network bandwidth is used for the RTP stream transfer. Before establishing a conversation, codec and ptime are negotiated through SIP signaling. The valid values of ptime range from 10 to 60, in increments of 10 milliseconds. The default ptime is 20ms. You can also disable the ptime negotiation.

#### Procedure

Configuration changes can be performed using the configuration files or locally.

<b>Configuration File</b>	<r0000000000xx>.conf/ <MAC>.conf	Configure the codecs to use on a per-line basis. Configure the priority and rtpmap for the enabled codec. Configure the ptime.
<b>Local</b>	Web User Interface	Configure the codecs to use and adjust the priority of the enabled codecs on a per-line basis. Configure the ptime. Navigate to: http://<phoneIPAddress>/cgi/do?id=3&id=2

**To configure the codecs to use and adjust the priority of the enabled codecs on a per-line basis via web user interface:**

1. Click on **Account > Advanced**.
2. Select the desired account from the pull-down list of **Account**.
3. Click on **Codec**.
4. Select the desired codec from the **Disable Codecs** column and then click  . The selected codec appears in the **Enable Codecs** column.
5. Repeat the step 4 to add more codecs to the **Enable Codecs** column.
6. To remove the codec from the **Enable Codecs** column, select the desired codec and then click .
7. To adjust the priority of codecs, select the desired codec and then click   
or .

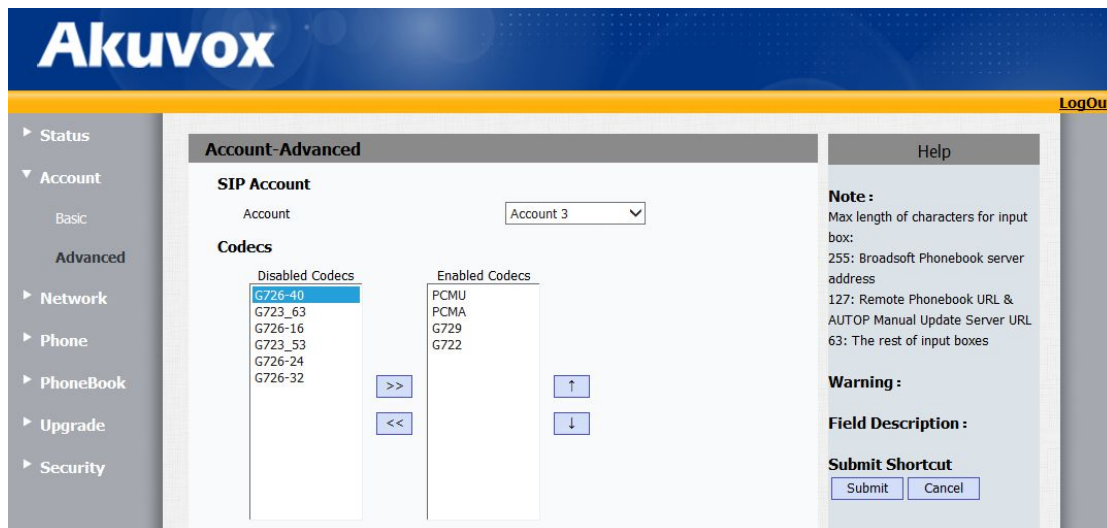

8. Click **Submit** to accept the change.

**To configure the ptime on a per-line basis via web user interface:**

1. Click on **Account > Advanced > Call**.
2. Select the desired account from the pull-down list of **Account**.
3. Select the desired value from the pull-down list of **PTime (ms)**.

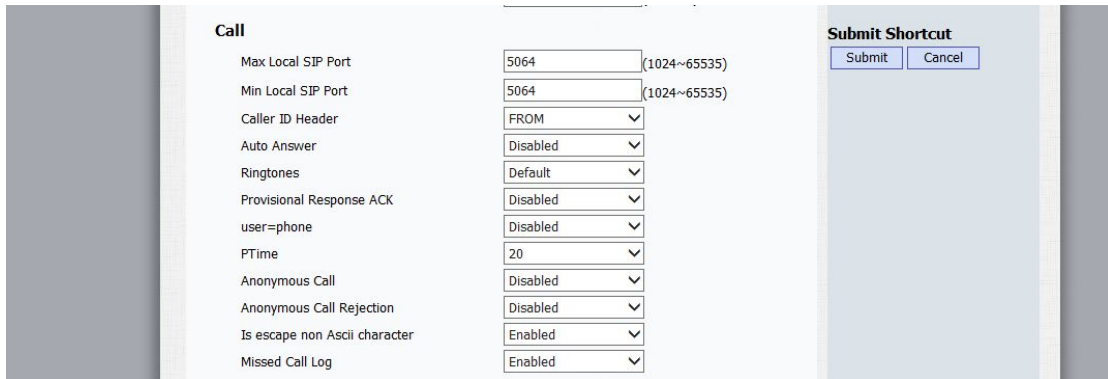

4. Click **Submit** to accept the change.

## Acoustic Clarity Technology

### Acoustic Echo Cancellation

Acoustic Echo Cancellation (AEC) is used to remove acoustic echo from a voice communication in order to improve the voice quality. It also increases the capacity achieved through silence suppression by preventing echo from traveling across a network. IP phones employ advanced AEC for hands-free operation. Echo cancellation is achieved using the echo canceller.

### Procedure

AEC can be configured using the configuration files or locally.

<b>Configuration File</b>	<r0000000000xx>.conf/ <MAC>.conf	Configure AEC.
<b>Local</b>	Web User Interface	Configure AEC. Navigate to: <a href="http://&lt;phoneIPAddress&gt;/fcgi/do?id=4&amp;id=3">http://&lt;phoneIPAddress&gt;/fcgi/do?id=4&amp;id=3</a>

### To configure AEC via web user interface:

1. Click on **Phone > Voice**.
2. Select the desired value from the pull-down list of **Echo Canceller**.



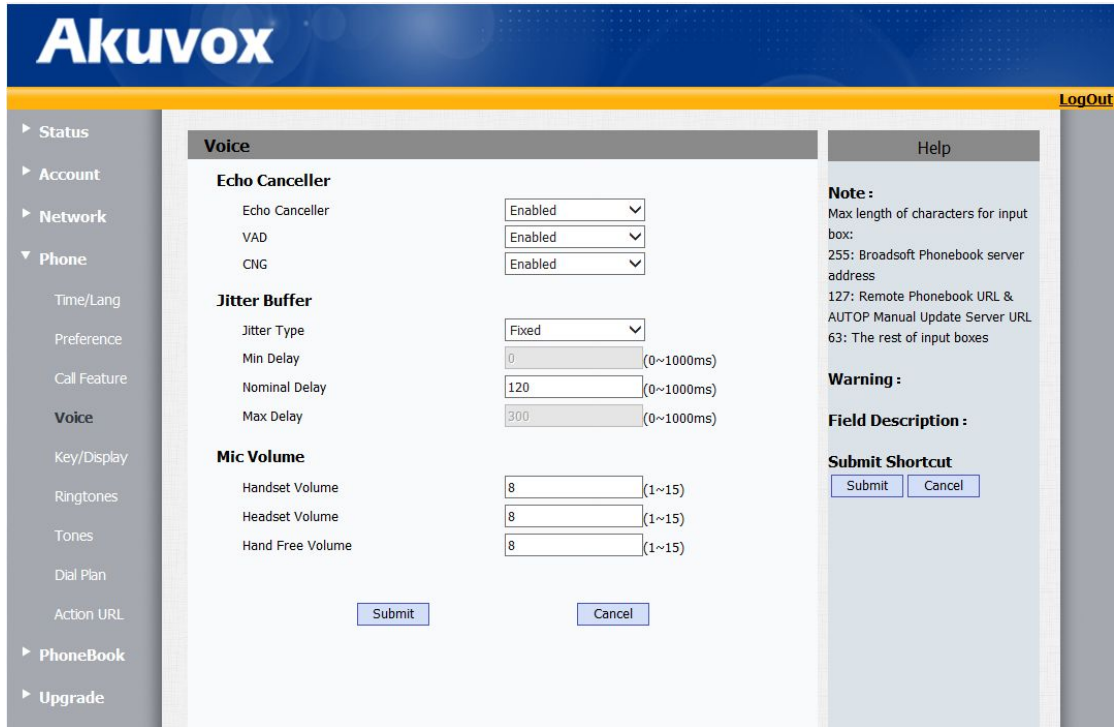

3. Click **Submit** to accept the change.

### Voice Activity Detection

Voice Activity Detection (VAD) is used in speech processing to detect the presence or absence of human speech. When detecting period of “silence”, VAD replaces that silence efficiently with special packets that indicate silence is occurring. It can facilitate speech processing, and deactivate some processes during non-speech section of an audio session. VAD can avoid unnecessary coding or transmission of silence packets in VoIP applications, saving on computation and network bandwidth.

#### Procedure

AEC can be configured using the configuration files or locally.

<b>Configuration File</b>	<r0000000000xx>.conf/ <MAC>.conf	Configure AEC.
<b>Local</b>	Web User Interface	Configure AEC. Navigate to: <a href="http://&lt;phoneIPAddress&gt;/fcgi/do?id=4&amp;id=3">http://&lt;phoneIPAddress&gt;/fcgi/do?id=4&amp;id=3</a>

#### To configure AEC via web user interface:

1. Click on **Phone > Voice**.
2. Select the desired value from the pull-down list of **VAD**.

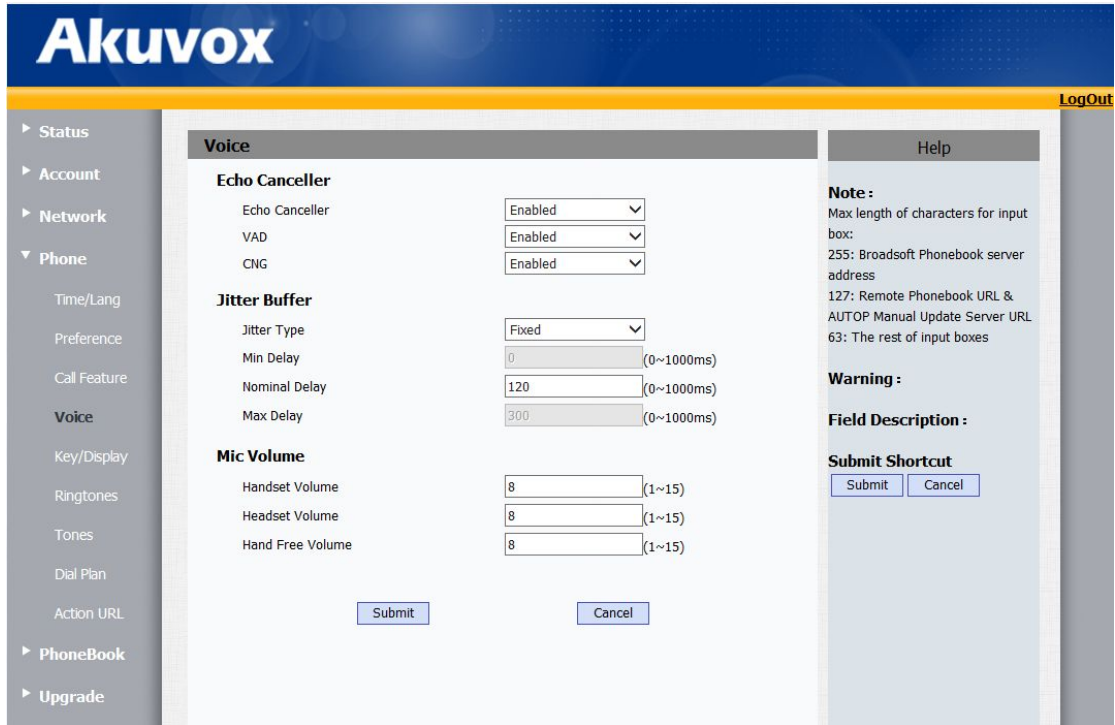

3. Click **Submit** to accept the change.

### Comfort Noise Generation

Comfort Noise Generation (CNG) is used to generate background noise for voice communications during periods of silence in a conversation. It is a part of the silence suppression or VAD handling for VoIP technology. CNG, in conjunction with VAD algorithms, quickly responds when periods of silence occur and inserts artificial noise until voice activity resumes. The insertion of artificial noise gives the illusion of a constant transmission stream, so that background sound is consistent throughout the call and the listener does not think the line has released. The purpose of VAD and CNG is to maintain an acceptable perceived QoS while simultaneously keeping transmission costs and bandwidth usage as low as possible.

### Procedure

CNG can be configured using the configuration files or locally.

<b>Configuration File</b>	<r0000000000xx>.conf/ <MAC>.conf	Configure CNG.
<b>Local</b>	Web User Interface	Configure CNG. Navigate to:

		http://<phoneIPAddress>/cgi/do?id=4&id=3
--	--	--

**To configure CNG via web user interface:**

1. Click on **Phone > Voice**.
2. Select the desired value from the pull-down list of **CNG**.

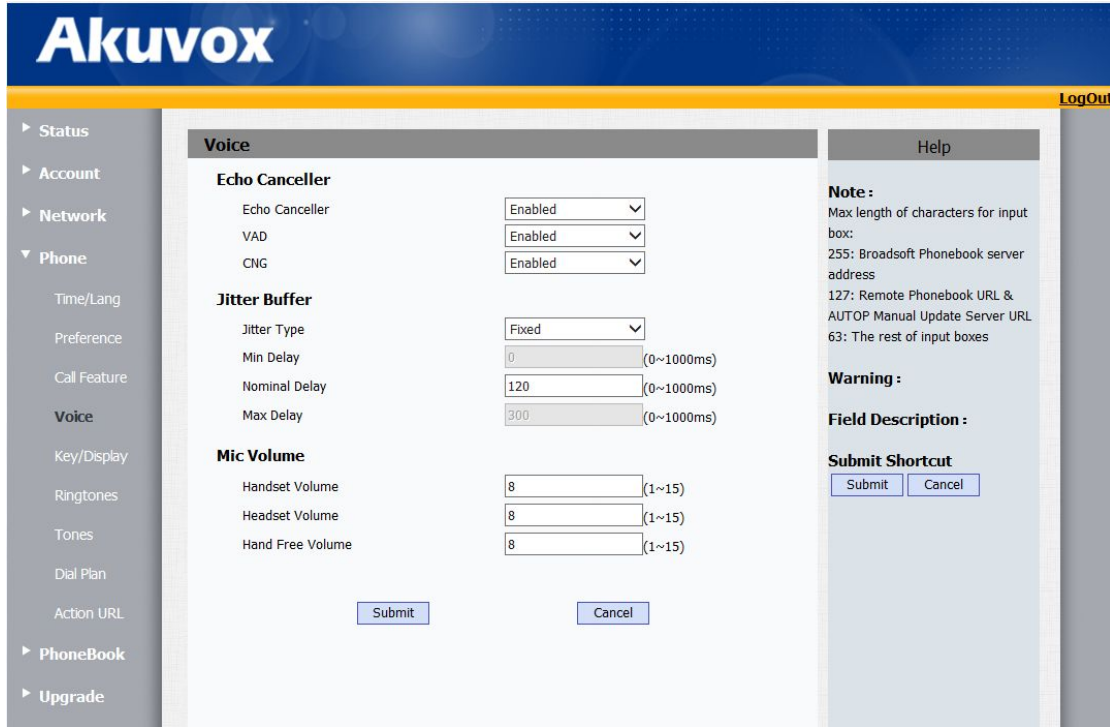

3. Click **Submit** to accept the change.

**Jitter buffer**

Jitter buffer is a shared data area where voice packets can be collected, stored, and sent to the voice processor in even intervals. Jitter is a term indicating variations in packet arrival time, which can occur because of network congestion, timing drift or route changes. The jitter buffer, located at the receiving end of the voice connection, intentionally delays the arriving packets so that the end user experiences a clear connection with very little sound distortion. IP phones support two types of jitter buffers: fixed and adaptive. A fixed jitter buffer adds the fixed delay to voice packets. You can configure the delay time for the static jitter buffer on IP phones. A adaptive jitter buffer is capable of adapting the changes in the network's delay. The range of the delay time for the dynamic jitter buffer added to packets can be also configured on IP phones.

**Procedure**

Jitter buffer can be configured using the configuration files or locally.

<b>Configuration File</b>	<code>&lt;r0000000000xx&gt;.conf/</code>	Configure the mode of jitter buffer and the
---------------------------	--	---

	<MAC>.conf	delay time for jitter buffer.
<b>Local</b>	Web User Interface	Configure the mode of jitter buffer and the delay time for jitter buffer. Navigate to: <a href="http://&lt;phoneIPAddress&gt;/cgi/do?id=4&amp;id=3">http://&lt;phoneIPAddress&gt;/cgi/do?id=4&amp;id=3</a>

**To configure Jitter Buffer via web user interface:**

1. Click on **Phone > Voice**.
2. Mark the desired radio box in the **Jitter Type** field.
3. Enter the minimum delay time for adaptive jitter buffer in the **Min Delay** field. Valid values range from 0 to 1000.
4. Enter the Nominal delay time for fixed or adaptive jitter buffer in the **Nominal Delay** field. Valid values range from 0 to 1000.
5. Enter the maximum delay time for adaptive jitter buffer in the **Max Delay** field. Valid values range from 0 to 1000.

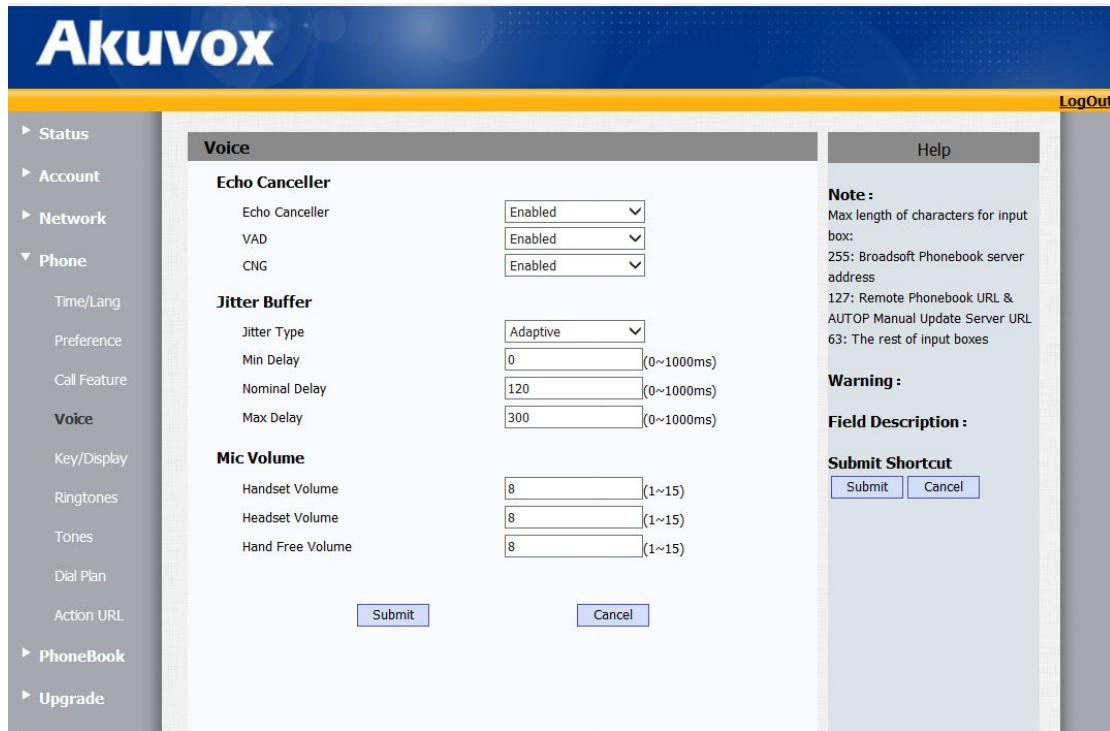

6. Click **Submit** to accept the change.

## Configuring Security Features

This chapter provides information for making configuration changes for the following security-related features:

- [Transport Layer Security](#)
- [Secure Real-Time Transport Protocol](#)

### Transport Layer Security

TLS is a commonly-used protocol for providing communications privacy and managing the security of message transmission, allowing IP phones to communicate with other remote parties and connect to the HTTPS URL for provisioning in a way that is designed to prevent eavesdropping and tampering.

TLS protocol is composed of two layers: TLS Record Protocol and TLS Handshake Protocol. The TLS Record Protocol completes the actual data transmission and ensures the integrity and privacy of the data. The TLS Handshake Protocol allows the server and client to authenticate each other and negotiate an encryption algorithm and cryptographic keys before data is exchanged.

The TLS protocol uses asymmetric encryption for authentication of key exchange, symmetric encryption for confidentiality, and message authentication codes for Integrity.

- Symmetric encryption: For symmetric encryption, the encryption key and the corresponding decryption key can be told by each other. In most cases, the encryption key is the same as the decryption key.
- Asymmetric encryption: For asymmetric encryption, each user has a pair of cryptographic keys – a public encryption key and a private decryption key. The information encrypted by the public key can only be decrypted by the corresponding private key and vice versa. Usually, the receiver keeps its private key. The public key is known by the sender, so the sender sends the information encrypted by the known public key, and then the receiver uses the private key to decrypt it.

IP phones support TLS version 1.0. A cipher suite is a named combination of authentication, encryption, and message authentication code (MAC) algorithms used to negotiate the security settings for a network connection using the TLS/SSL network protocol. IP phones support the following cipher suites:

- DHE-RSA-AES256-SHA

- DHE-DSS-AES256-SHA
- AES256-SHA
- EDH-RSA-DES-CBC3-SHA
- EDH-DSS-DES-CBC3-SHA
- DES-CBC3-SHA
- DHE-RSA-AES128-SHA
- DHE-DSS-AES128-SHA
- AES128-SHA
- IDEA-CBC-SHA
- DHE-DSS-RC4-SHA
- RC4-SHA
- RC4-MD5
- EXP1024-DHE-DSS-DES-CBC-SHA
- EXP1024-DES-CBC-SHA
- EDH-RSA-DES-CBC-SHA
- EDH-DSS-DES-CBC-SHA
- DES-CBC-SHA
- EXP1024-DHE-DSS-RC4-SHA
- EXP1024-RC4-SHA
- EXP1024-RC4-MD5
- EXP-EDH-RSA-DES-CBC-SHA
- EXP-EDH-DSS-DES-CBC-SHA
- EXP-DES-CBC-SHA
- EXP-RC4-MD5

### **Certificates**

The IP phone can serve as a TLS client or a TLS server. The TLS requires the following security certificates to perform the TLS handshake:

- **Client Certificate:** When the IP phone requests a TLS connection with a server, the IP phone should verify the certificate sent by the server to decide whether it is client based on the client certificates list. The IP phone has 30 built-in client certificates. You can upload 10 custom certificates at most. The format of the client certificate files must be \*.pem, \*.cer, \*.crt and \*.der and the maximum file size is 5MB.
- **Server Certificate:** When clients request a TLS connection with the IP phone, the IP phone sends the server certificate to the clients for authentication. The IP phone has two types of built-in server certificates: a unique server certificate and a generic server certificate. You can only upload one server certificate to the IP phone. The old server certificate will be

overridden by the new one. The format of the server certificate files must be \*.pem and \*.cer and the maximum file size is 5MB.

- A unique server certificate: It is unique to an IP phone (based on the MAC address) and issued by the Akuvox Certificate Authority (CA).
- A generic server certificate: It issued by the Akuvox Certificate Authority (CA). Only if no unique certificate exists, the IP phone may send a generic certificate for authentication.

The IP phone can authenticate the server certificate based on the client certificates list.

The client certificates list and the server certificates list contain the default and custom certificates. You can specify the type of certificates the IP phone accepts: default certificates, custom certificates or all certificates.

Common Name Validation feature enables the IP phone to mandatorily validate the common name of the certificate sent by the connecting server.

### Procedure

Configuration changes can be performed using the configuration files or locally.

<b>Configuration File</b>	<r000000000xx>.conf/ <MAC>.conf	Configure TLS on a per-line basis. Configure client certificates feature.
<b>Local</b>	Web User Interface	Configure TLS on a per-line basis. Navigate to: <a href="http://&lt;phoneIPAddress&gt;/fcgi/do?id=3&amp;id=1">http://&lt;phoneIPAddress&gt;/fcgi/do?id=3&amp;id=1</a> Configure client certificates feature. Upload the client certificates. Navigate to: <a href="http://&lt;phoneIPAddress&gt;/fcgi/do?id=7&amp;id=2">http://&lt;phoneIPAddress&gt;/fcgi/do?id=7&amp;id=2</a>

### To configure TLS on a per-line basis via web user interface:

1. Click on **Account->Basic**.
2. Select the desired account from the pull-down list of **Account**.
3. Select TLS from the pull-down list of **Transport**.

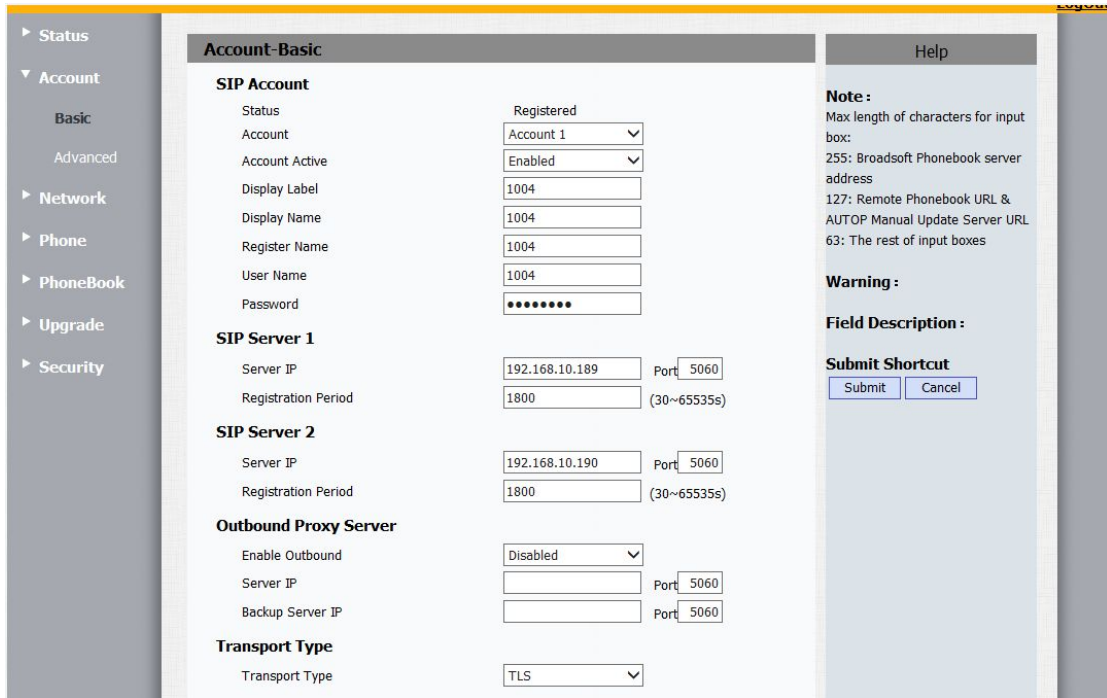

4. Click **Submit** to accept the change.

**To upload a client certificate via web user interface:**

1. Click on **Security > Advanced**.
2. Click **Browse** to select the certificate (\*.pem, \*.crt, \*.cer or \*.der) from your local System.

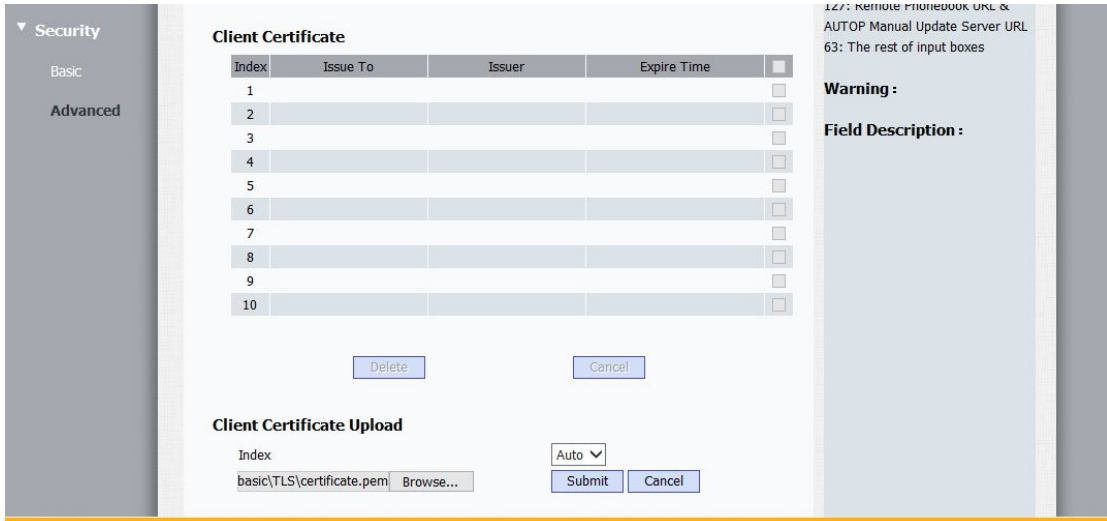

3. Click **Submit** to upload the certificate.

## Secure Real-Time Transport Protocol

Secure Real-Time Transport Protocol (SRTP) encrypts the RTP streams during VoIP phone calls to avoid interception and eavesdropping. The parties participating in the call must enable SRTP



feature simultaneously. When this feature is enabled on both phones, the type of encryption to utilize for the session is negotiated between the IP phones. This negotiation process is compliant with RFC 4568.

When a user places a call on the enabled SRTP phone, the IP phone sends an INVITE message with the RTP encryption algorithm to the destination phone.

**Procedure**

SRTP can be configured using the configuration files or locally.

<b>Configuration File</b>	<r0000000000xx>.conf/ <MAC>.conf	Configure SRTP feature on a per-line basis.
<b>Local</b>	Web User Interface	Configure SRTP feature on a per-line basis. Navigate to: <a href="http://&lt;phoneIPAddress&gt;/fcgi/do?id=3&amp;id=2">http://&lt;phoneIPAddress&gt;/fcgi/do?id=3&amp;id=2</a>

**To configure SRTP feature via web user interface:**

1. Click on **Account > Advanced**.
2. Select the desired account from the pull-down list of **Account**.
3. Select the desired value from the pull-down list of **Voice Encryption (SRTP)**.

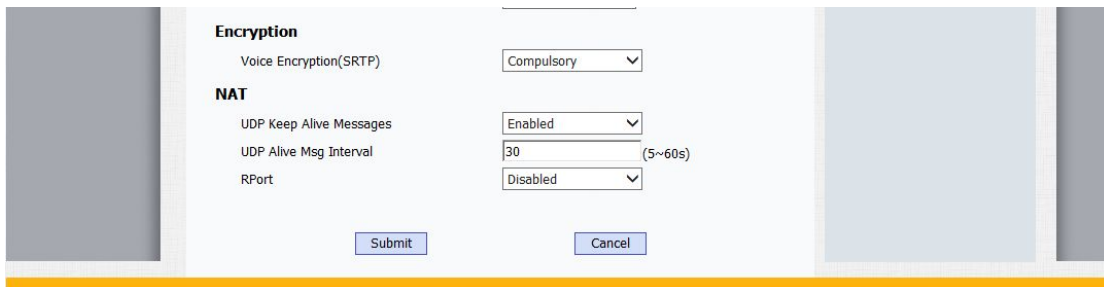

4. Click **Submit** to accept the change.

## Resource Files

When configuring particular features, you may need to upload resource files (e.g., local contact directory, remote phone book) to IP phones. The resources files can be local contact directory, remote phone book and so on. Ask Akuvox field application engineer for resource file templates. If the resource file is to be used for all IP phones of the same model, the resource file access URL is best specified in the <r0000000000xx>.conf file. However, if you want to specify the desired phone to use the resource file, the resource file access URL should be specified in the <MAC>.conf file.

This chapter provides the detailed information on how to customize the following resource files and specify the access URL:

- [Local Contact File](#)
- [Remote XML Phone Book](#)

## Local Contact File

You can add contacts one by one on the IP phone directly. You can also add multiple contacts at a time and/or share contacts between IP phones using the local contact template file. After setup, place the template file to the provisioning server and specify the access URL of the template file in the configuration files.

When editing a local contact template, learn the following:

<ContactData> indicates the start of a contact list and </ContactData> indicates the end of a contact list.

</Group> indicates the start of a group list and </Group> indicates the end of a group list.

When specifying a ring tone for a contact or a group, the format of the value must be Auto (the first registered line), Resource:RingN.wav and Bellcore-drN.wav(system ring tone, integer N ranges from 1 to 9 for RingN.wav, from 1 to 5 for Bellcore-drN.wav) or Custom:Name.wav (custom ring tone).

When specifying a desired line for a contact, the valid values are 0 and line ID, 0 stands for the first available account. Multiple line IDs are separated by commas.

At most 5 groups can be added to the IP phone.

At most 500 local contacts can be added to the IP phone.

### Procedure

Use the following procedures to customize a local contact template file.

To customize a local contact file:

1. Open the template file using an ASCII editor.
2. For each group that you want to add, add the following string to the file. Each starts on a separate line:

```
<Group Id="" Name="" Ring="" Description="">
```

#### Where:

Name="" specifies the name of the group.

Ring="" specifies the desired ring tone for this group.

3. For each contact that you want to add, add the following string to the file. Each starts on a separate line:

```
<Contact Id="" Line="" DisplayName=""
  OfficeNumber="" MobileNumber="" OtherNumber="" Ring="" />
```

**Where:**

Line="" specifies the line you want to add this contact to.

DisplayName="" specifies the name of the contact (This value cannot be blank or duplicated).

OfficeNumber="" specifies the office number of the contact.

MobileNumber="" specifies the mobile number of the contact.

OtherNumber="" specifies the other number of the contact.

Ring="" specifies the ring tone for this contact.

4. Specify the values within double quotes.

5. Place this file to the provisioning server.

The following shows an example of a local contact file:

```
<?xml version="1.0" encoding="UTF-8" ?>
<ContactData>
  <Group Id="1" Name="Default" Ring="Auto" Description="">
    <Contact Id="1" Line="0" DisplayName="1111" OfficeNumber="1111"
  MobileNumber="1111" OtherNumber="1111" Ring="Bellcore-dr3.wav" />
    <Contact Id="2" Line="2" DisplayName="2222" OfficeNumber="2222"
  MobileNumber="2222" OtherNumber="2222" Ring="Ring2.wav" />
    <Contact Id="3" Line="1" DisplayName="3333" OfficeNumber="3333"
  MobileNumber="3333" OtherNumber="3333" Ring="Ring8.wav" />
  </Group>
  <Group Id="2" Name="test" Ring="Ring4.wav" Description="">
    <Contact Id="4" Line="2" DisplayName="4444" OfficeNumber="4444"
  MobileNumber="4444" OtherNumber="4444" Ring="Ring2.wav" />
  </Group>
</ContactData>
```

**To Import/Export Contract xml file via web user interface:**

1. Click on **PhoneBook > Local Book > Import/Export**.
2. Select **Export key** to export the contracts from the phone in a xml file.
3. Select **Import key** to import a xml file of contracts from the PC.

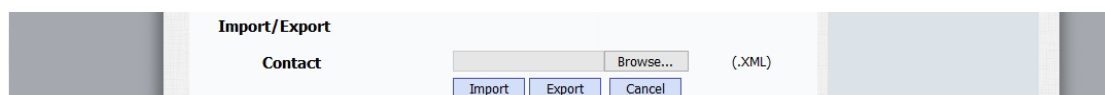

## Remote XML Phone Book

IP phones can access 5 remote phone books. You can customize the remote XML phone book for IP phones as required. Before specifying the access URL of the remote phone book in the configuration files, you need to create a remote XML phone book and then place it to the provisioning server.

When creating an XML phone book, learn the following:

- <Directory Name=""> indicates the start of a phone book and
- </Directory> indicates the end of a phone book.
- <Contact indicates the start of a contact and /> indicates the end of a contact.

### Procedure

Use the following procedures to customize an XML phone book.

Customizing an XML phone book:

1. Open the template file using an ASCII editor.
2. For each contact that you want to add, add the following strings to the phone book. <Contact Id="1" Name = "001" Office="1068" Mobile="001b" Other="001c"/>

### Where:

- Name = "" specify the contact name.
- Office="" specifies the office number of the contact.
- Mobile="" specifies the mobile number of the contact.
- Other="" specifies the other number of the contact.

3. Specify the values within double quotes.
4. Place this file to the provisioning server.

The following shows an example of an XML phone book:

```
<?xml version="1.0" encoding="utf-8" ?>
<Directory Name="Akuvox">
<Contact Id="1" Name = "001" Office="1068" Mobile="001b" Other="001c"/>
<Contact Id="501" Name = "501" Office="501a" Mobile="501b" Other="501c"/>
</Directory>
```

Remote phone book URL can be configured using the configuration files or locally.

<b>Configuration File</b>	<r0000000000xx>.conf/ <MAC>.conf	Configure Remote phone book URL.
<b>Local</b>	Web User Interface	Remote phone book URL. Navigate to: <a href="http://&lt;phoneIPAddress&gt;/fcgi/do?id=3&amp;id=2">http://&lt;phoneIPAddress&gt;/fcgi/do?id=3&amp;id=2</a>

**To configure Remote phone book URL feature via web user interface:**

1. Click on **PhoneBook > Remote Book**.
2. Input the **Local Book URL** and **Local Book Name** for remote phone book URL and display name.

**Akuvox** LogOut

▶ Status  
▶ Account  
▶ Network  
▶ Phone  
▼ PhoneBook  
    Local Book  
    **Remote Book**  
    Call Log  
    LDAP  
    Broadsoft  
▶ Upgrade  
▶ Security

### Remote Book

Index	Local Book URL	Local Book Name
1	tftp://192.168.10.179/remote_contact.xml	remote_contact.xml
2	ftp://abc123:123456@192.168.10.206/remote_contact.xml	remote_contact.xml2
3		
4		
5		

### Help

**Note :**  
Max length of characters for input box:  
255: Broadsoft Phonebook server address  
127: Remote Phonebook URL & AUTOP Manual Update Server URL  
63: The rest of input boxes

**Warning :**

**Field Description :**

**Submit Shortcut**

3. Click **Submit** to accept the change.

## Troubleshooting

Troubleshooting is a form of problem solving, it will help an administrator to solve some common problems. It is a logical, systematic search for the source of a problem so that it can be solved.

Troubleshooting Methods are as following

- [Viewing Log Files](#)
- [Capturing Packets](#)
- [Analyzing Configuration File](#)

### Viewing Log Files

Log files show the device behavior, it usually is needed when you can export the log files to a syslog server or the local system. You can also specify the severity level of the log to be reported to a log file. The default system log level is 3. In the configuration files, you can use the following parameters to configure system log settings:

Loglevel -- Specify the system log level.

The following lists the log level of events you can log:

- 0: Emergency
- 1: Alert
- 2: Critical condition
- 3: Error conditions
- 4: Warning conditions
- 5: Notice
- 6: Informational
- 7: Debug

**To configure the level of the system log via web user interface:**

1. Click on **Settings > Configuration**.
2. Select the desired level from the pull-down list of **System Log Level**.

The screenshot shows the 'Upgrade-Advanced' configuration page in the Akuvox web interface. The 'System Log' section is highlighted, showing the 'LogLevel' dropdown menu set to '7' and an 'Export' button. Other sections include 'PNP Option' (PNP Config: Disabled), 'DHCP Option' (Custom Option: 128-254), 'Manual Update Server' (URL, User Name, Password, Common AES Key, AES Key(MAC)), 'AutoP' (Mode: Power On, Schedule: Sunday 22, Hour(0~23)), and 'PCAP' (Start, Stop, Export buttons). A 'Submit' and 'Cancel' button are also present at the bottom of the main configuration area.

3. Click **Confirm** to accept the change.

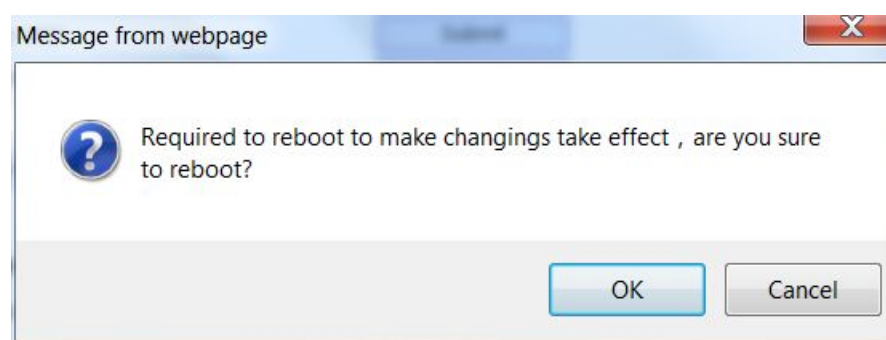

4. Click **OK** to reboot the IP phone.
- After a reboot, the system log level is set as 7, the informational level.

**To export a log file to the local system via web user interface:**

1. Click on **Update > Advanced > System Log**.
2. Click **Export** to open file download window, and then save the file to your local system.

## Capturing Packets

Akuvox IP phones allow users to capture packets via web interface, or other packet captured tools. The captured packets are troubleshooting purpose.

### To capture packets via web user interface:

1. Click on **Update->Advanced->PACP**.
2. Click **Start** to start capturing signal traffic.
3. Reproduce the issue to get stack traces.
4. Click **Stop** to stop capturing.
5. Click **Export** to open the file download window, and then save the file to your local system.

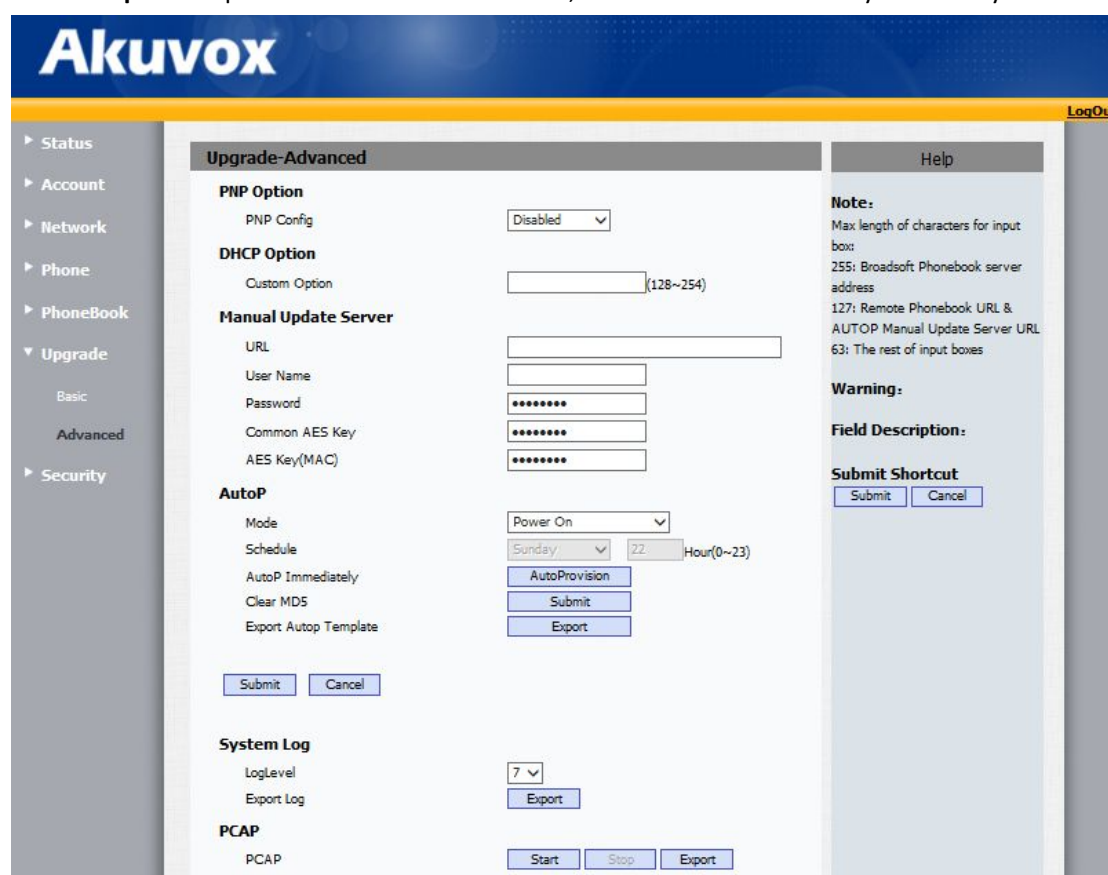

The screenshot shows the 'Upgrade-Advanced' configuration page in the Akuvox web interface. The page is divided into several sections:

- PNP Option:** PNP Config is set to 'Disabled'.
- DHCP Option:** Custom Option is an empty text box with a '(128~254)' label.
- Manual Update Server:** URL, User Name, Password, Common AES Key, and AES Key(MAC) are all empty text boxes.
- AutoP:** Mode is 'Power On', Schedule is 'Sunday' at '22:00' (Hour(0~23)). Buttons for 'AutoProvision', 'Submit', and 'Export' are present.
- System Log:** LogLevel is '7'. An 'Export' button is available.
- PCAP:** Buttons for 'Start', 'Stop', and 'Export' are visible.

On the right side, there is a 'Help' section with a 'Note' about character limits for input boxes and a 'Warning' section. At the bottom right, there is a 'Submit Shortcut' section with 'Submit' and 'Cancel' buttons.

### To capture packets using the Ethernet software:

Connect the Internet port of the IP phone and the PC to the same HUB, and then use one of the packet captured software to capture the signal traffic.



## Analyzing Configuration File

Some system errors or bugs may due to incorrect configurations. You can export configuration file to check the current configuration of the IP phone and troubleshoot if Necessary.

**To export configuration file via web user interface:**

1. Click on **Upgrade->Advanced**.
2. Click **Export** to open the file download window, and then save the file to your local system.

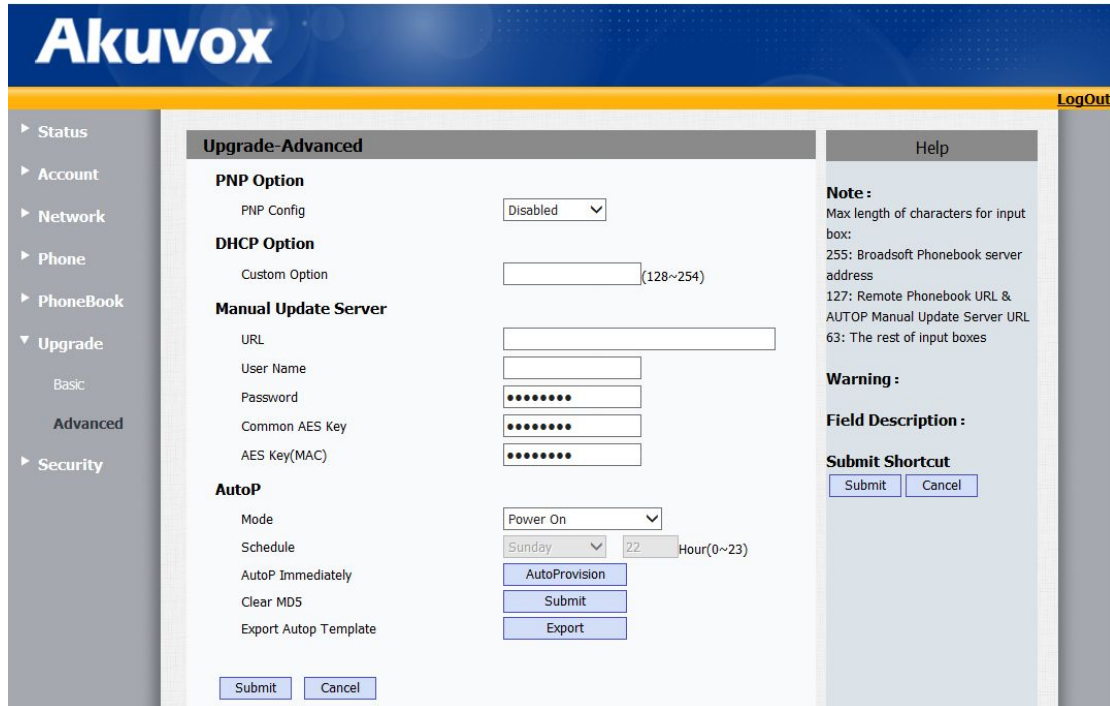

**Akuvox** LogOut

**Upgrade-Advanced**

**PNP Option**  
PNP Config: Disabled

**DHCP Option**  
Custom Option: (128~254)

**Manual Update Server**  
URL:   
User Name:   
Password:   
Common AES Key:   
AES Key(MAC):

**AutoP**  
Mode: Power On  
Schedule: Sunday 22 Hour(0~23)  
AutoP Immediately:   
Clear MD5:   
Export Autop Template:

**Help**

**Note :**  
Max length of characters for input box:  
255: Broadsoft Phonebook server address  
127: Remote Phonebook URL & AUTOP Manual Update Server URL  
63: The rest of input boxes

**Warning :**

**Field Description :**

**Submit Shortcut**

## Troubleshooting Solutions

### Why is the LCD screen blank?

Make sure the IP phone is plugged into an AC outlet.

Make sure the IP phone is connected to a switch which is in a good condition.

If your phone is PoE powered, ensure that you are using a PoE-compliant switch or Hub.

## **Why does the IP phone not get an IP address?**

Make sure the Ethernet cable is in a good condition.

Make sure the Ethernet cable is correctly plug into the Internet port on the IP phone.

Make sure the network parameters are set correctly.

Make sure that your network switch or hub is operational.

## **How do I find the basic information of the IP phone?**

Press the OK key when the IP phone is idle to check the basic information (e.g., IP address, MAC address and firmware version).

## **Why does the IP phone not upgrade firmware successfully?**

Do one of the following:

- Ensure that the target firmware is not the same as the current firmware.

- Ensure that the target firmware is applicable to the IP phone model.

- Ensure that the power is on and the network is available in the process of upgrading.

- Ensure that the web browser is not closed or refreshed when upgrading firmware via web user interface.

## **Why does the IP phone not display time and date correctly?**

Note that the time and date can be obtained from the NTP server automatically or manually configuration. If a NTP server is not available, or the IP phone cannot access the NTP server, you now should consider to configure the date and time manually.

## **What is the difference between a remote phone book and a local phone book?**

A remote phone book is stored on a server, and anyone who have access to the server can use remote phone book. A local phone book is placed on the IP phone flash, only a specific user can use the local phone book. A remote phone book is always used as a central phone book for a company; each employee can load it to obtain the real-time data from the same server.

## **What is the difference among user name, register name and display name?**

User name identifies the account. Register name that goes with a password is for authentication purposes for account registration. Display name is the caller ID that will be displayed on the callee's phone LCD screen.

## **How to increase or decrease the volume?**

Volume can be adjusted by pressing the physical volume key to increase or decrease the ringer volume, or the volume settings can be done via web interface.

## **What will happen if I connect both PoE cable and power adapter?**

IP phones will work properly even using both PoE cable and power adapter.

## **What is auto provisioning?**

Auto provisioning is the ability to deploy IP phones by using pre-defined procedures that are carried out electronically without requiring human intervention. The phone configuration parameters, local phone book, and firmware can be updated via auto provisioning.

## What is PnP?

Plug and Play (PnP) is a method for IP phones to acquire the provisioning server address. With PnP enabled, the IP phone broadcasts the PnP SUBSCRIBE message to obtain a provisioning server address during startup. Any SIP server recognizing the message will respond with the preconfigured provisioning server address, so the IP phone will be able to download the CONF files from the provisioning server. PnP depends on support from a SIP server.

## Why doesn't the IP phone update the configuration?

Make sure that the configuration is correct.

Reboot the IP phone. Some configurations will take effect after reboot

Make sure that the configuration is applicable to the IP phone model.

Sometimes, the configuration is correctly set, but the server does not support it.

## How to solve the IP conflict problem?

Try to set the IP address to another IP address

If static IP is selected, try DHCP.

## How to reset the IP phone to factory configurations?

If you are experiencing a problem, and it is still there after trying all troubleshooting methods, please try to reset the IP phone to factory configurations. Note that all custom settings will be overwritten after resetting.

To reset the IP phone via web user interface:

1. Click on **Upgrade > Basic**.
2. Click Reset to Factory Reset in the **Reset to Factory Setting** field.

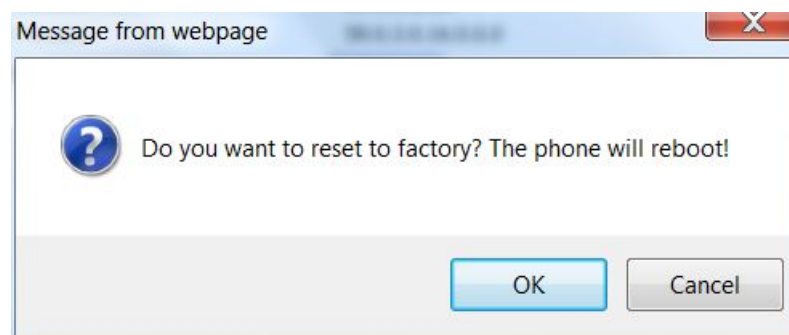
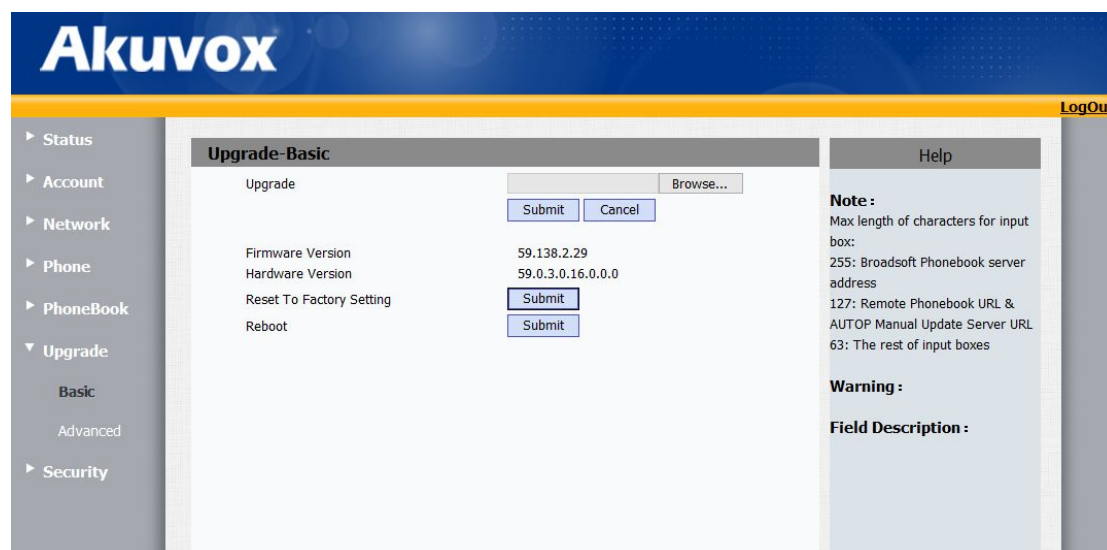

## How to restore the administrator password?

Administrator password will be reset the original password after factory reset. All custom settings will be overwritten after reset.

## What are the main differences among SP-R50P, SP-R52P, SP-R53P, and SP-R59P?

Phone Model	LCD	Line Key	DSS Key	SMS	XML Browser
SP-R50P	2.3" 132x64	/	/	support	support
SP-R52P	2.3" 132x64	2	/	support	support
SP-R53P	2.9" 132x64	3	/	support	support
SP-R59P	4.3" 480x272	6	10	support	support

# Appendix

## Appendix A: Glossary

**802.1x**--an IEEE Standard for port-based Network Access Control (PNAC). It is a part of the IEEE 802.1 group of networking protocols. It provides an authentication mechanism to devices wishing to attach to a LAN or WLAN.

**ACD** (Automatic Call Distribution)--used to distribute calls from large volumes of incoming calls to the registered IP phone users.

**ACS** (Auto Configuration server)--responsible for auto-configuration of the Central Processing Element (CPE).

**Cryptographic Key**--a piece of variable data that is fed as input into a cryptographic algorithm to perform operations such as encryption and decryption, or signing and verification.

**DHCP** (Dynamic Host Configuration Protocol)--built on a client-server model, where designated DHCP server hosts allocate network addresses and deliver configuration parameters to dynamically configured hosts.

**DHCP Option**--can be configured for specific values and enabled for assignment and distribution to DHCP clients based on server, scope, class or client-specific levels.

**DNS** (Domain Name System)--a hierarchical distributed naming system for computers, services, or any resource connected to the Internet or a private network.

**EAP-MD5** (Extensible Authentication Protocol-Message Digest Algorithm 5)—only provides authentication of the EAP peer to the EAP server but not mutual authentication.

**EAP-TLS** (Extensible Authentication Protocol-Transport Layer Security) –provides for mutual authentication, integrity-protected cipher suite negotiation between two endpoints.

**PEAP-MSCHAPv2** (Protected Extensible Authentication Protocol-Microsoft Challenge Handshake Authentication Protocol version 2) –provides for mutual authentication, but does not require a client certificate on the IP phone.

**HTTP** (Hypertext Transfer Protocol)--used to request and transmit data on the World Wide Web.

**HTTPS** (Hypertext Transfer Protocol over Secure Socket Layer)--a widely-used communications protocol for secure communication over a network.

**IEEE** (Institute of Electrical and Electronics Engineers)--a non-profit professional association headquartered in New York City that is dedicated to advancing technological innovation and excellence.

**LAN** (Local Area Network)--used to interconnects network devices in a limited area such as a home, school, computer laboratory, or office building.

**PnP** (Plug and Play)--a term used to describe the characteristic of a computer bus, or device specification, which facilitates the discovery of a hardware component in a system, without the need for physical device configuration, or user intervention in resolving resource conflicts.

**ROM** (Read-only Memory)--a class of storage medium used in computers and other electronic devices.

**RTP** (Real-time Transport Protocol)--provides end-to-end service for real-time data.

**TCP** (Transmission Control Protocol)--a transport layer protocol used by applications that require guaranteed delivery.

**UDP** (User Datagram Protocol)--a protocol offers non-guaranteed datagram delivery.

**URI** (Uniform Resource Identifier)--a compact sequence of characters that identifies an abstract or physical resource.

**URL** (Uniform Resource Locator)--specifies the address of an Internet resource.

**VLAN** (Virtual LAN)-- a group of hosts with a common set of requirements, which communicate as if they were attached to the same broadcast domain, regardless of their physical location.

**VoIP** (Voice over Internet Protocol)--a family of technologies used for the delivery of voice communications and multimedia sessions over IP networks.

**WLAN** (Wireless Local Area Network)--a type of local area network that uses high-frequency radio waves rather than wires to communicate between nodes.

**XML-RPC** (Remote Procedure Call Protocol)--which uses XML to encode its calls and HTTP as a transport mechanism.

## Appendix B: Time Zones

Time Zone	Time Zone Name
-11:00	Samoa
-10:00	United States-Hawaii-Aleutian
-10:00	United States-Alaska-Aleutian
-09:00	United States-Alaska Time
-08:00	Canada(Vancouver, Whitehorse)
-08:00	Mexico(Tijuana, Mexicali)
-08:00	United States-Pacific Time
-07:00	Canada(Edmonton, Calgary)
-07:00	Mexico(Mazatlan, Chihuahua)
-07:00	United States-Mountain Time
-07:00	United States-MST no DST
-06:00	Canada-Manitoba(Winnipeg)
-06:00	Chile(Easter Islands)
-06:00	Mexico(Mexico City, Acapulco)
-06:00	United States-Central Time
-05:00	Bahamas(Nassau)
-05:00	Canada(Montreal, Ottawa, Quebec)
-05:00	Cuba(Havana)
-05:00	United States-Eastern Time
-04:30	Venezuela(Caracas)
-04:00	Canada(Halifax, Saint John)
-04:00	Chile(Santiago)
-04:00	Paraguay(Asuncion)
-04:00	United Kingdom-Bermuda(Bermuda)
-04:00	United Kingdom(Falkland Islands)
-04:00	Trinidad&Tobago
-03:30	Canada-New Foundland(St.Johns)
-03:00	Denmark-Greenland(Nuuk)



-03:00	Argentina(Buenos Aires)
--------	-------------------------

Time Zone	Time Zone Name
-03:00	Brazil(no DST)
-03:00	Brazil(DST)
-02:00	Brazil(no DST)
-01:00	Portugal(Azores)
0	GMT
0	Greenland
0	Denmark-Faroe Islands(Torshavn)
0	Ireland(Dublin)
0	Portugal(Lisboa, Porto, Funchal)
0	Spain-Canary Islands(Las Palmas)
0	United Kingdom(London)
0	Morocco
+01:00	Albania(Tirane)
+01:00	Austria(Vienna)
+01:00	Belgium(Brussels)
+01:00	Caicos
+01:00	Chad
+01:00	Spain(Madrid)
+01:00	Croatia(Zagreb)
+01:00	Czech Republic(Prague)
+01:00	Denmark(Kopenhagen)
+01:00	France(Paris)
+01:00	Germany(Berlin)
+01:00	Hungary(Budapest)
+01:00	Italy(Rome)
+01:00	Luxembourg(Luxembourg)
+01:00	Macedonia(Skopje)
+01:00	Netherlands(Amsterdam)
+01:00	Namibia(Windhoek)

+02:00	Estonia(Tallinn)
--------	------------------

Time Zone	Time Zone Name
+02:00	Turkey(Ankara)
+02:00	Ukraine(Kyiv, Odessa)
+03:00	East Africa Time
+03:00	Iraq(Baghdad)
+03:00	Russia(Moscow)
+03:30	Iran(Teheran)
+04:00	Armenia(Yerevan)
+04:00	Azerbaijan(Baku)
+04:00	Georgia(Tbilisi)
+04:00	Kazakhstan(Aktau)
+04:00	Russia(Samara)
+04:30	Afghanistan
+05:00	Kazakhstan(Aqtobe)
+05:00	Kyrgyzstan(Bishkek)
+05:00	Pakistan(Islamabad)
+05:00	Russia(Chelyabinsk)
+05:30	India(Calcutta)
+06:00	Kazakhstan(Astana, Almaty)
+06:00	Russia(Novosibirsk, Omsk)
+07:00	Russia(Krasnoyarsk)
+07:00	Thailand(Bangkok)
+08:00	China(Beijing)
+08:00	Singapore(Singapore)
+08:00	Australia(Perth)
+09:00	Korea(Seoul)
+09:00	Japan(Tokyo)
+09:30	Australia(Adelaide)
+09:30	Australia(Darwin)

+10:00	Australia(Sydney, Melbourne, Canberra)
--------	--

Time Zone	Time Zone Name
+10:00	Australia(Brisbane)
+10:00	Australia(Hobart)
+10:00	Russia(Vladivostok)
+10:30	Australia(Lord Howe Islands)
+11:00	New Caledonia(Noumea)
+12:00	New Zealand(Wellington, Auckland)
+12:45	New Zealand(Chatham Islands)
+13:00	Tonga(Nukualofa)

## Appendix C: Configuration Parameters

This appendix describes configuration parameters in the configuration files for each feature. The configuration files are <r0000000000xx>.conf/<MAC>.conf.

### Setting Parameters in Configuration Files

You can set parameters in the configuration files to configure IP phones. <r0000000000xx>.conf and <MAC>.conf files are stored on the provisioning server. The IP phone checks for configuration files and looks for resource files when restarting the IP phone. The <r0000000000xx>.conf file stores configurations for all phones of the same model. The <MAC>.conf file stores configurations for a specific IP phone with that MAC address. Configuration changes made in the <MAC>.conf file override the configuration settings in the

## Basic and advanced parameters

### Note

The parameters included here are examples only. Not all possible parameters are shown in this table

Parameter Name	Description
Config.Autoprovision. General.Url	Configure the url of the auto provisioning server. The range of the value length is 1~255 characters.
Config.Autoprovision. General.Username	Configure the username and password for the phone to be authenticated by the auto provision server. The range of the value length is 1~63 characters.
Config.Autoprovision. General.Pwd	
Config.Autoprovision. Mode.Mode	Configure the auto provision mode. 0:Disable(default); 1:Power On; 2:Repeatedly; 3:Power On + Repeatedly.
Config.Autoprovision.Schedule.DayOfWeek	Configure the schedule time for auto provision when the auto provision mode is Repeatedly or Power On + Repeatedly. DayOfWeek: The range is 0~7, 0 is for everyday , 1~7 is for Monday~Sunday. HourOfDay: The range is 0~23.
Config.Autoprovision.Schedule.HourOfDay	
Config.Autoprovision. AES.Key16	Configure Aes key (16 bytes) for decrypting the common config file.
Config.Autoprovision. AES.Key16Mac	Configure Aes key (16 bytes) for decrypting the Mac-Oriented config file.
Config.Autoprovision.Pnp.Enable	Enable or Disable the PnP feature. 0:Disabled. 1:Enabled(default).
Config.Autoprovision. Dhcp_Option.Enable	Enable or Disable the DHCP option mode. 0:Disabled. 1:Enabled(default).
Config.Autoprovision. Dhcp_Option.CustomId	Configure the DHCP custom option. The range of the value is 128~254.
Config.Network.Lan.Type	Configure the LAN port type. 0:DHCP(default). 1:PPPoE. 2:Static IP.

Config.Network.Lan. StaticIP	Configure the Static IP address for the phone.
Config.Network.Lan. SubnetMask	Configure the mask for the phone.
Config.Network.Lan. DefaultGateway	Configure the gateway for the phone.
Config.Network.Lan.PrimaryDNS	Configure the Primary DNS server for the phone.
Config.Network.Lan.SecondaryDNS	Configure the Secondary DNS server for the phone.
Config.Network.Pppoe. User	Configure the username and password for PPPOE connection. The range of the value length is 1~63 characters.
Config.Network.Pppoe. Pwd	
Config.Network.Vlan.LanVlanEnable	Enable or Disable the LAN port VLAN. 0:Disabled(default). 1:Enabled.
Config.Network.Vlan.LanVid	Configure the LAN port VLAN ID. The range of the value is 0~4094. (0 by default).
Config.Network.Vlan.LanPriority	Configure the LAN port VLAN priority. The range of the value is 0~7.(0 by default).
Config.Network.Vlan.PcVlanEnable	Enable or Disable the PC port VLAN. 0:Disabled(default). 1:Enabled.
Config.Network.Vlan.PcVid	Configure the PC port VLAN ID. The range of the value is 0~4094. (0 by default).
Config.Network.Vlan.PcPriority	Configure the PC port VLAN priority. The range of the value is 0~7.(0 by default).
Config.Network.Snmp.Enable	Enable or disable the SNMP feature. 0:Disabled(default). 1:Enabled.
Config.Network.Snmp.Port	Configure the SNMP port. The range of the value is 1~65535.
Config.Network.Snmp.TrustedIP	Configure the IP address of the SNMP server.
Config.Network.PC.Type	Configure the PC port type. 0: Router. 1: Bridge.
Config.Network.PC.RouterIP	Configure the router IP when the PC type is 0.
Config.Network.PC.SubnetMask	Configure the router subnet mask when the PC type is 0.
Config.Network.PC.EnableDhcp	Enable or disable the DHCP when the PC type is 0. 0:Disabled(default). 1:Enabled.
Config.Network.PC.StartIP	Configure the start IP when the PC type is 0.
Config.Network.PC.EndIP	Configure the end IP when the PC type is 0.
Config.Network.RtpPort.Max	Configure the max and min RTP port. The range of the value is 1024~65535.
Config.Network.RtpPort.Min	

Config.Network.Qos.SignalTos	Configure the signaltos value of the QoS. The range of the value is 0~63.
Config.Network.Qos.RtpTos	Configure the rtpTos value of the QoS. The range of the value is 0~63.
Config.Network.LLDP.LLDPEnable	Enable or disable the LLDP feature. 0:Disabled(default). 1:Enabled.
Config.Network.LLDP.Interval	Configure the LLDP interval time. The range of the value is 0~3600(in seconds).
Config.Network.VPN.Enable	Enable or disable the VPN feature. 0:Disabled(default). 1:Enabled.
Config.TR069.General.Enable	Enable or disable the TR069 feature. 0:Disabled (default). 1:Enabled.
Config.TR069.ManagementServer.Username	Configure the username and password for the phone to authenticate with the ACS.
Config.TR069.ManagementServer.Password	The range of the value length is 1~63 characters.
Config.TR069.ManagementServer.Url	Configure the access URL of the ACS. The range of the value length is 1~63 characters.
Config.TR069.ManagementServer.ConnectionRequestUser name	Configure the username and password for the phone to authenticate the connection requests.
Config.TR069.ManagementServer.connectionRequestPass word	The range of the value length is 1~63 characters.
Config.TR069.ManagementServer.PeriodicInformEnable	Enable or disable the phone to report its configuration information to the ACS. 0:Disabled (default). 1:Enabled.
Config.TR069.ManagementServer.PeriodicInformInterval	Configure the interval for the phone to report its configuration information to the ACS. The range of the value is 3~3600(in seconds).
Config.AccountX.General.Enable	Enable or disable the account X(X ranges from 1 to 3). 0:Disabled(default). 1:Enabled.
Config.AccountX.General.Label	Configure the account X(X ranges from 1 to 3) label which will display on the LCD screen. The range of the value length is 1~63 characters.
Config.AccountX.General.DisplayName	Configure the display name of account X(X ranges from 1 to 3). The range of the value length is 1~63 characters.
Config.AccountX.General.Username	Configure the register user name of account X(X ranges from 1 to 3). The range of the value length is 1~63 characters.

Config.AccountX.General.AuthName	Configure the user and password for register authentication. The range of the value length is 1~63 characters.
Config.AccountX.General.Pwd	
Config.AccountX.Sip.Server	Configure the SIP server address of account X(X ranges from 1 to 3). The range of the value length is 1~63 characters.
Config.AccountX.Sip.Server2	Configure the backup SIP server address of account X(X ranges from 1 to 3). The range of the value length is 1~63 characters.
Config.AccountX.Sip.Port	Configure the SIP server port of account X(X ranges from 1 to 3). The range of the value is 1~65535.
Config.AccountX.Sip.Port2	Configure the backup SIP server port of account X(X ranges from 1 to 3). The range of the value is 1~65535.
Config.AccountX.Sip.TransType	Configure the transport type. 0:UDP(Default). 1:TCP. 2:TLS.
Config.AccountX.Sip.ListenPort	Configure the listen port of account X(X ranges from 1 to 3). The range of the value is 1~65535.
Config.AccountX.OutProxy.Enable	Enable or Disable the outbound proxy server. 0:Disabled(default). 1:Enabled.
Config.AccountX.OutProxy.Server	Configure the IP address/domain of the outbound proxy server. The range of the value length is 1~63 characters.
Config.AccountX.OutProxy.Port	Configure the IP address/domain of the outbound proxy server port. The range of the value is 1~65535.
Config.AccountX.OutProxy.BakServer	Configure the backup outbound proxy server address. The range of the value length is 1~63 characters.
Config.AccountX.OutProxy.BakPort	Configure the backup outbound proxy server port. The range of the value is 1~65535.
Config.AccountX.Stun.Enable	Enable or Disable Stun. 0:Disabled(default). 1:Enabled.
Config.AccountX.Stun.Server	Configure the stun server address. The range of the value length is 1~63 characters.
Config.AccountX.Stun.Port	Configure the stun server port. The range of the value is 1~65535.
Config.AccountX.Encryption.SRTPEncryption	Enable or Disable SRTP Encryption.

	0:Disabled(Default). 1:Enabled.
Config.AccountX.NAT.UdpKeepEnable	Enable or Disable NAT keep-alive. 0:Disabled(Default). 1:Enabled.
Config.AccountX.NAT.UdpKeepInterval	Configure the NAT keep-alive interval. The range of the value is 15~60(in seconds).Default is 30.
Config.AccountX.NAT.NatTraversal	Configure the NAT Traversal.
Config.AccountX.NAT.StunServer	Configure the NAT stun server address. The range of the value length is 1~63 characters.
Config.AccountX.NAT.StunPort	Configure the NAT stun server port. The range of the value is 1~65535.
Config.AccountX.NAT.Rport	Configure the rport. The range of the value is 1~65535.
Config.AccountX.Blf.SubscribePeriod	Configure the BLF subscribe period(1800 seconds by default). The range of the value is 1800~65535(in seconds).Default is 1800.
Config.AccountX.Blf.BlfListUri	Configure the Blf List Uri. The range of the value is 1~65535.
Config.AccountX.VoiceMsg.Number	Configure the voice message number. The range of the value length is 1~63 characters.
Config.AccountX.Auto_Answer.Enable	Enable or Disable auto answer when receiving a incoming call for account X(X ranges from 1 to 3). 0:Disabled(Default). 1:Enabled.
Config.AccountX.Subscribe.SubscribeRegister	Enable or Disable subscribe the register status. 0:Disabled(Default). 1:Enabled.
Config.AccountX.Subscribe.SubscribePeriod	Configure the subscribe period of the register(in seconds), the range is 1800~65535, default is 1800.
Config.AccountX.Subscribe.SubscribeACDExpire	Configure the subscribe period of the ACD(in seconds), the range is 1800~65535, default is 1800.
Config.AccountX.Subscribe.SubsribeMWI	Enable or Disable subscribe the MWI status; 0:Disabled(Default); 1:Enabled
Config.AccountX.Subscribe.SubscribeMWIExpire	Configure the subscribe period of the MWI(in seconds), the range is 1800~65535, default is 1800.
Config.AccountX.Call.Enable100Rel	Enable or Disable 100 reliable retransmission; 0:Disabled(Default); 1:Enabled.
Config.AccountX.Call.Ptime	Configure the RTP packet time.



	0(Disabled), 10, 20, 30, 40, 50, 60.
Config.AccountX.Reg.Timeout	Configure the register expire time(in seconds), the range is 1800~65535, default is 1800.
Config.AccountX.Reg.Timeout2	Configure the second register expire time(in seconds), the range is 1800~65535, default is 1800.
Config.AccountX.Dtmf.Type	Configure the DTMF type. 0:Inband; 1:RFC2833(Default); 2:Info; 3:Inband + Info; 4:Info + RFC2833.
Config.AccountX.Dtmf.Payload	Configure the RFC2833 payload, ranges from 96 to 225 (101 by default).
Config.AccountX.Dtmf.InfoType	Configure DTMF info type when using Info. 0:Disabled(default); 1:DTMF-Relay; 2:DTMF; 3:Telephone-Event.
Config.AccountX.Dtmf.Duration	Configure the DTMF duration time.
Config.AccountX.Dtmf.Power	Configure the DTMF power.
Config.AccountX.Anonymous_Call.Enable	Enable or Disable Anonymous Call; 0:Disabled(Default); 1:Enabled.
Config.AccountX.Anonymous_Call.OnCode	Configure On Code for Anonymous Call. The range of the value length is 1~63 characters.
Config.AccountX.Anonymous_Call.OffCode	Configure Off Code for Anonymous Call. The range of the value length is 1~63 characters.
Config.AccountX.Reject_AnonymousCall.Enable	Enable or Disable Reject Anonymous Call; 0:Disabled(Default); 1:Enabled.
Config.AccountX.Reject_AnonymousCall.OnCode	Configure On Code for Reject Anonymous Call. The range of the value length is 1~63 characters.
Config.AccountX.Reject_AnonymousCall.OffCode	Configure Off Code for Reject Anonymous Call. The range of the value length is 1~63 characters.
Config.AccountX.Music_Server.Enable	Enable or Disable Music Server; 0:Disabled(Default); 1:Enabled.
Config.AccountX.Music_Server.Uri	Configure Music Server Uri. The range of the value length is 1~63 characters.
Config.AccountX.Session.EnableTimer	Enable or Disable Session timer; 0:Disabled(Default); 1:Enabled.
Config.AccountX.Session.Interval	Configure the session interval time(in seconds),

	the range is 1800~65535, default is 1800.
Config.AccountX.Session.Refreshers	Configure the session refresh time(in seconds), the range is 1800~65535, default is 1800.
Config.AccountX.AOC.AocEnable	Enable or Disable AOC; 0:Disabled(Default); 1:Enabled.
Config.AccountX.Audio.Y.Enable	Enable or Disable Audio codecs Y(Y ranges from 1 to 13) for account X (X ranges from 1 to 3).
Config.Forward.Always.Enable	Enable or Disable Always Forward; 0:Disabled(Default); 1:Enabled.
Config.Forward.Always.Target	Configure target phone number that the phone will Always Forward to. The range of the value length is 1~63 characters.
Config.Forward.Always.OnCode	Configure On Code for Always Forward. The range of the value length is 1~63 characters.
Config.Forward.Always.OffCode	Configure Off Code for Always Forward. The range of the value length is 1~63 characters.
Config.Forward.Busy.Enable	Enable or Disable Busy Forward; 0:Disabled(Default); 1:Enabled.
Config.Forward.Busy.Target	Configure target phone number that the phone will Busy Forward to. The range of the value length is 1~63 characters.
Config.Forward.Busy.OnCode	Configure On Code for Busy Forward. The range of the value length is 1~63 characters.
Config.Forward.Busy.OffCode	Configure Off Code for Busy Forward. The range of the value length is 1~63 characters.
Config.Forward.Timeout.Enable	Enable or Disable No Answer Forward; 0:Disabled(Default); 1:Enabled.
Config.Forward.Timeout.Target	Configure target phone number that the phone will No Answer Forward to. The range of the value length is 1~63 characters.
Config.Forward.Timeout.Timeout	Configure No answer timeout the time after which the call will be forwarded when using No Answer Forward, the range is 0~45(in seconds).
Config.Forward.Timeout.OnCode	Configure On Code for No Answer Forward. The range of the value length is 1~63 characters.
Config.Forward.Timeout.OffCode	Configure Off Code for No Answer Forward. The range of the value length is 1~63 characters.
Config.Forward.CallPark.Enable	Enable or Disable Call Park. 0:Disabled(Default); 1:Enabled.

Config.Forward.CallPark.Target	Configure target phone number that the phone will Call Park to. The range of the value length is 1~63 characters.
Config.Forward.CallPark.Line	Configure line that the phone will Call Park to. The value is 0(Default), 1, 2.
Config.BroadSoft.BroadSoftX.DisplayName	Configure the display name of BroadSoft phonebook X ("X" ranges from 0-5). The range of the value length is 1~63 characters.
Config.BroadSoft.BroadSoftX.Server	Configure the url of BroadSoft phonebook X ("X" ranges from 0-5). The range of the value length is 1~255 characters.
Config.BroadSoft.BroadSoftX.Port	Configure the port of BroadSoft phonebook X ("X" ranges from 0-5). The range of the value is 1~65535.
Config.BroadSoft.BroadSoftX.Username	Configure the username of BroadSoft phonebook X ("X" ranges from 0-5). The range of the value length is 1~63 characters.
Config.BroadSoft.BroadSoftX.Password	Configure the password of BroadSoft phonebook X ("X" ranges from 0-5). The range of the value length is 1~63 characters.
Config.RemotePhoneBook.Remote_Phone_BookX.Display Name	Configure the display name of Remote phonebook X ("X" ranges from 0-4). The range of the value length is 1~63 characters.
Config.RemotePhoneBook.Remote_Phone_BookX.Url	Configure the url of Remote phonebook X ("X" ranges from 0-4). The range of the value length is 1~255 characters.
Config.Ldap.Ldap.NameFilter	Configure the search criteria for name and number lookups.
Config.Ldap.Ldap.NumberFilter	The range of the value length is 1~63 characters.
Config.Ldap.Ldap.Server	Configure the LDAP server. The range of the value length is 1~63 characters.
Config.Ldap.Ldap.Port	Configure the LDAP server port. The range of the value is 1~65535.
Config.Ldap.Ldap.Root	Configure the LDAP root path. The range of the value length is 1~63 characters.
Config.Ldap.Ldap.Username	Configure the LDAP username and password.
Config.Ldap.Ldap.Password	The range of the value length is 1~63 characters.
Config.Ldap.Ldap.MaxHits	Configure the maximum displayed search results, ranges from 1 to 32000(50 by default),the valid value is Integer.
Config.Ldap.Ldap.NameAttr	Configure the search attribute for name and number lookups.
Config.Ldap.Ldap.NumberAttr	
Config.Ldap.Ldap.DisplayName	The range of the value length is 1~63 characters.

Config.Ldap.Ldap.SearchDelay	Configure the search delay time,ranges from 0 to 2000, (in milliseconds, 0 by default).
Config.AreaCode.General.Code	Configure the area code. The range of the value length is 1~63 characters.
Config.AreaCode.General.MaxLen	Configure the max length of the area code. The range of the value is 1~15.
Config.AreaCode.General.MinLen	Configure the min length of the area code. The range of the value is 1~15.
Config.AreaCode.Account	Configure the line of area code; the valid value is: 0(default), 1, 2, 3; 0 is for auto.
Config.Features.Call_Waiting.Enable	Enable or disable the call waiting feature; 0:Disabled; 1:Enabled(default).
Config.Features.Call_Waiting.PlayTone	Configure the phone to play warning tone when receiving an incoming call during an active call; 0:Disabled; 1:Enabled(default).
Config.Features.Hotline.Enable	Enable or disable the hotline feature; 0:Disabled(default); 1:Enabled
Config.Features.Hotline.Number	Configure the hotline number. The range of the value length is 1~63 characters.
Config.Features.Hotline.Delay	Configure the hotline delay time(in seconds). The range of the value is 0~5.
Config.Features.DND.Enable	Enable or disable the DND feature; 0:Disabled(default); 1:Enabled.
Config.Features.DND.OnCode	Configure On Code for DND. The range of the value length is 1~63 characters.
Config.Features.DND.OffCode	Configure Off Code for DND. The range of the value length is 1~63 characters.
Config.Features.DND.ReturnCode	Configure return code for DND; the valid value is: 404(Not Found); 480(Temporarily Unavailable); 486(Busy Here).
Config.Features.Reject.ReturnCode	Configure return code for Reject; the valid value is: 404(Not Found); 480(Temporarily Unavailable); 486(Busy Here).
Config.Features.Intercom.Enable	Enable or disable the intercom feature; 0-Disabled; 1-Enabled(default).
Config.Features.Intercom.Mute	Enable or disable the phone to mute the speaker when automatically answer an intercom call,

	0-Disabled(default); 1-Enabled.
Config.Features.DialNow.Delay	Configure the delay time of the dial now feature(in seconds). The range of the value is 0~5.
Config.Features.AutoAnswer.Delay	Configure the delay time of the auto answer feature(in seconds). The range of the value is 0~5.
Config.Features.ACD.ACDAutoAvailable	Enable or disable the ACD Auto Available feature; 0-Disabled(default); 1-Enabled.
Config.Features.ACD.ACDAutoAvailableTime	Configure the time of the ACD Auto Available feature(in seconds).
Config.Features.SpeedDial.LabelX	Configuration of Dial X ("X" ranges from 01-12). The range of the value length is 1~63 characters.
Config.Features.SpeedDial.NumberX	Configuration of Speed Dial X ("X" ranges from 1-12). The range of the value length is 1~63 characters.
Config.Features.SpeedDial.LineX	Configuration of Speed Dial X ("X" ranges from 1-12); the valid value is: 0(default), 1, 2, 3; 0 is for auto.
Config.Features.ActionUrl.SetupCompleted	Configuration of Action url key word.
Config.Features.ActionUrl.Registered	
Config.Features.ActionUrl.Unregistered	
Config.Features.ActionUrl.RegisterFailed	
Config.Features.ActionUrl.OffHook	
Config.Features.ActionUrl.OnHook	
Config.Features.ActionUrl.IncomingCall	
Config.Features.ActionUrl.OutgoingCall	
Config.Features.ActionUrl.Established	
Config.Features.ActionUrl.Terminated	
Config.Features.ActionUrl.OpenDND	
Config.Features.ActionUrl.CloseDND	
Config.Features.ActionUrl.OpenAlwaysForward	
Config.Features.ActionUrl.CloseAlwaysForward	
Config.Features.ActionUrl.OpenBusyForward	
Config.Features.ActionUrl.CloseBusyForward	
Config.Features.ActionUrl.OpenNoAnswerForward	
Config.Features.ActionUrl.CloseNoAnswerForward	
Config.Features.ActionUrl.TransferCall	
Config.Features.ActionUrl.BlindTransfer	
Config.Features.ActionUrl.AttendedTransfer	
Config.Features.ActionUrl.Hold	

Config.Features.ActionUrl.UnHold	
Config.Features.ActionUrl.Mute	
Config.Features.ActionUrl.UnMute	
Config.Features.ActionUrl.MissedCall	
Config.Features.ActionUrl.IPChanged	
Config.Features.ActionUrl.ForwardInComingCall	
Config.Features.ActionUrl.RejectInComingCall	
Config.Features.ActionUrl.AnswerNewInCall	
Config.Features.ActionUrl.TransferFinished	
Config.Features.ActionUrl.TransferFailed	
Config.Features.ActionUrl.IdleToBusy	
Config.Features.ActionUrl.BusyToIdle	
Config.Features.ActionUrl.Enable	
Config.Features.RemoteControl.ActionURIAllowIPList	
Config.Settings.Language.Type	Configure the language displays on the phone LCD screen, the available values are: 0-English(default), 1-Chinese_s.
Config.Settings.General.DirectIP	Enable or disable direct IP; 0:Disabled; 1:Enabled(default).
Config.Settings.DateDisplay.DisplayMode	Configure the date display mode.
Config.Settings.Language.WebLang	Configure the language displays on the web page, the available values are: 0-English(default), 1-Chinese_s.
Config.Settings.SNTP.Enable	Enable or disable the NTP feature; 0:Disabled; 1:Enabled(default).
Config.Settings.SNTP.TimeZone	Configure the time zone and time zone name for the phone; time zone ranges from -11 to +12 (0 by default); time zone name (GMT by default).
Config.Settings.SNTP.Name	
Config.Settings.SNTP.NTPServer1	Configure the primary and secondary NTP servers. Default is 0.pool.ntp.org.
Config.Settings.SNTP.NTPServer2	
Config.Settings.SNTP.Interval	Configure the update interval(in seconds) when using NTP Server(3600 by default). The valid value is >=3600.
Config.Settings.SNTP.DTS	Configure the daylight saving time feature. 0:Disabled, 1:Enabled, 2:Automatic(default).
Config.Settings.DateTime.Type	Configure the DST type when the DST was set to Enabled.

	0:Date, 1:Week.
Config.Settings.SNTP.StartTime	Configure the start time of DST.(1/1/0 by default) If the DST type is set to By Date, the value format is Month/Day/Hour; If the DST type is set to By Week, the value format is Start Month/Start Day of Week/Start Day of Week Last in Month/Start Hour of Day. For example, the value is 1/4/2/5, it means the start time is at 5 o'clock on Tuesday, the 4th week in January;
Config.Settings.SNTP.EndTime	Configure the end time of DST, (12/31/23 by default), the value format is the same as the start time.
Config.Settings.DateTime.Offset	Configure the offset time (in minutes), ranges from -300 to 300,(60 by default) the valid value is Integer.
Config.Settings.DateTime.TimeFormat	Configure the time format, 0-12 Hour, 1-24 Hour(default).
Config.Settings.Backlight.Level	Configure the backlight level, Integer,0, 1, 2, 3, 4(default), 5.
Config.Settings.Backlight.Time	Configure the backlight time, 0-Always off, 1-Always on, 10, 20(default), 30, 40, 50, 60, 90, 120(in seconds).
Config.Settings.LogLevel.Level	Configure the log level, Integer,0, 1, 2, 3(default), 4, 5, 6, 7.
Config.Settings.RingTone.Type	Configure the ring tone type, string(Ring1.wav by default).
Config.Settings.Audio.KeyVol	Configure the keyboard volume, the range is 1~15, default is 8.
Config.Settings.Audio.RingVol	Configure the ring volume, the range is 1~15, default is 8.
Config.Settings.HandFree.SpKVol	Configure the hand free speak volume, the range is 1~15, default is 8.
Config.Settings.HandFree.MicVol	Configure the hand free mic volume, the range is 1~15, default is 8.
Config.Settings.HandFree.SigToneVol	Configure the hand free signal tone volume, the range is 1~15, default is 8.
Config.Settings.HandSet.SpKVol	Configure the hand set speak volume, the range is 1~15, default is 8.
Config.Settings.HandSet.MicVol	Configure the hand set mic volume, the range is 1~15, default is 8.
Config.Settings.HandSet.SigToneVol	Configure the hand set signal tone volume, the range is 1~15, default is 8.

Config.Settings.HeadSet.SpKVol	Configure the head set speak volume, the range is 1~15, default is 8.
Config.Settings.HeadSet.MicVol	Configure the head set mic volume, the range is 1~15, default is 8.
Config.Settings.HeadSet.SigToneVol	Configure the head set signal tone volume, the range is 1~15, default is 8.
Config.Settings.Login.Password	Configure the login password of the advanced settings on the phone UI(admin by default). The range of the value length is 1~63 characters.
Config.Settings.Web_Login.Password	Configure the login password of the web(admin by default). The range of the value length is 1~63 characters.
Config.Settings.CallTimeOut.DialIn	Configure the timeout of the dial in or dial out(in seconds, 60 by default).
Config.Settings.CallTimeOut.DialOut	
Config.Settings.Ringer.KeywordX	Configure the distinctive ring X ("X" ranges from 01-10).
Config.Settings.Ringer.RingtoneX	The range of the value length is 1~63 characters.
Config.Settings.HotDesking.ServerName	Configure the HotDesking server name.
Config.Settings.HotDesking.ServerPort	Configure the HotDesking server port.
Config.Settings.HotDesking.OutBoundName	Configure the HotDesking outbound server name.
Config.Settings.HotDesking.OutBoundPort	Configure the HotDesking outbound server port.
Config.Settings.HotDesking.PhoneName	Configure the HotDesking phone name.
Config.Settings.HotDesking.RegisterName	Configure the HotDesking register name.
Config.Settings.HotDesking.PassWord	Configure the HotDesking password.
Config.Settings.HotDesking.ServerName2	Configure the HotDesking backup server name.
Config.Settings.HotDesking.ServerPort2	Configure the HotDesking backup server port.
Config.Programable.LineKeyX.Type	Configure the type of the Programmable line key X ("X" ranges from 1-3). The range of Type is: 1~19. 1:DND; 2:Menu; 3:MSG; 4:Status; 5:Book; 6:Fwd; 7:PickUp; 8:Group PickUp; 9:Intercom; 10:Speed Dial; 11:History; 12:Favorite; 13:Redial; 14:Account; 15:ACD; 16:BLF; 17:BLFList;18:Call Return;19:Hot Desking.
Config.Programable.LineKeyX.Label	Configure the label of the Programmable line key X ("X" ranges from 1-3). The range of the value length is 1~63 characters.
Config.Programable.LineKeyX.Param1	The param1 is used to configure the value of the programmable line key X ("X" ranges from 1-3). The param1 is only used for line key type (7, 8, 9, 10, 16). For line key type 7, param1 is the pick up target. For line key type 8, param1 is the group pick up



	<p>target.</p> <p>For line key type 9, param1 is the intercom number.</p> <p>For line key type 10, param1 is the speed dial number.</p> <p>For line key type 16, param1 is the BLF number.</p> <p>The range of the value length is 1~63 characters.</p>
Config.Programable.LineKeyX.Param2	<p>The param2 is used to configure the account information of the programmable line key X ("X" ranges from 1-3).</p> <p>0:Auto, 1:Account 1, 2:Account 2, 3:Account 3.</p>
Config.Programable.LineKeyX.Param3	<p>The param3 is used to configure the extension value of the programmable line key X ("X" ranges from 1-3).</p> <p>The param3 is only used for line key type (16).</p> <p>For line key type 16, param3 is the BLF Feature code.</p> <p>The range of the value length is 1~63 characters.</p>
Config.Programable.SoftKeyX.Type	<p>Configure the type of the Programmable soft key X ("X" ranges from 01-04).</p> <p>The range of Type is: 1~15.</p> <p>1:DND; 2:Menu; 3:MSG; 4:Status; 5:Book; 6:Fwd; 7:PickUp; 8:Group PickUp; 9:Intercom; 10:Speed Dial; 11:History; 12:Favorite; 13:Redial; 14:Call Return;15:Hot Desking.</p>
Config.Programable.SoftKeyX.Label	<p>Configure the label of the Programmable soft key X ("X" ranges from 1-4).</p> <p>The range of the value length is 1~63 characters.</p>
Config.Programable.SoftKeyX.Param1	<p>The param1 is used to configure the value of the programmable line key X ("X" ranges from 1-3).</p> <p>The param1 is only used for line key type (7, 8, 9, 10).</p> <p>For line key type 7, param1 is the pick up target.</p> <p>For line key type 8, param1 is the group pick up target.</p> <p>For line key type 9, param1 is the intercom number.</p> <p>For line key type 10, param1 is the speed dial number.</p> <p>The range of the value length is 1~63 characters.</p>
Config.Programable.SoftKeyX.Param2	<p>The param2 is used to configure the account</p>

	<p>information of the programmable line key X ("X" ranges from 1-3).</p> <p>0:Auto, 1:Account 1, 2:Account 2, 3:Account 3.</p>
Config.Programable.OK.Type	<p>Configure the type of the Programmable OK key.</p> <p>The range of Type is: 1~15.</p> <p>1:DND; 2:Menu; 3:MSG; 4:Status; 5:Book; 6:Fwd; 7:PickUp; 8:Group PickUp; 9:Intercom; 10:Speed Dial; 11:History; 12:Favorite; 13:Redial; 14:Call Return;15:Hot Desking.</p>
Config.Programable.OK.Param1	<p>The param1 is used to configure the value of the programmable line key X ("X" ranges from 1-3).</p> <p>The param1 is only used for line key type (7, 8, 9, 10).</p> <p>For line key type 7, param1 is the pick up target.</p> <p>For line key type 8, param1 is the group pick up target.</p> <p>For line key type 9, param1 is the intercom number.</p> <p>For line key type 10, param1 is the speed dial number.</p> <p>The range of the value length is 1~63 characters.</p>
Config.Programable.OK.Param2	<p>The param2 is used to configure the account information of the programmable line key X ("X" ranges from 1-3).</p> <p>0:Auto, 1:Account 1, 2:Account 2, 3:Account 3.</p>
Config.Programable.Cancel.Type	<p>Configure the type of the Programmable Cancel key.</p> <p>The range of Type is: 0~15.</p> <p>0:N/A; 1:DND; 2:Menu; 3:MSG; 4:Status; 5:Book; 6:Fwd; 7:PickUp; 8:Group PickUp; 9:Intercom; 10:Speed Dial; 11:History; 12:Favorite; 13:Redial; 14:Call Return;15:Hot Desking.</p>
Config.Programable.Cancel.Param1	<p>The param1 is used to configure the value of the programmable line key X ("X" ranges from 1-3).</p> <p>The param1 is only used for line key type (7, 8, 9, 10).</p> <p>For line key type 7, param1 is the pick up target.</p> <p>For line key type 8, param1 is the group pick up</p>

	<p>target.</p> <p>For line key type 9, param1 is the intercom number.</p> <p>For line key type 10, param1 is the speed dial number.</p> <p>The range of the value length is 1~63 characters.</p>
Config.Programable.Cancel.Param2	<p>The param2 is used to configure the account information of the programmable line key X ("X" ranges from 1-3).</p> <p>0:Auto, 1:Account 1, 2:Account 2, 3:Account 3.</p>
Config.Programable.FWD.Type	<p>Configure the type of the Programmable FWD key.</p> <p>The range of Type is: 1~15.</p> <p>1:DND; 2:Menu; 3:MSG; 4:Status; 5:Book; 6:Fwd; 7:PickUp; 8:Group PickUp; 9:Intercom; 10:Speed Dial; 11:History; 12:Favorite; 13:Redial; 14:Call Return;15:Hot Desking.</p>
Config.Programable.FWD.Param1	<p>The param1 is used to configure the value of the programmable line key X ("X" ranges from 1-3).</p> <p>The param1 is only used for line key type (7, 8, 9, 10).</p> <p>For line key type 7, param1 is the pick up target.</p> <p>For line key type 8, param1 is the group pick up target.</p> <p>For line key type 9, param1 is the intercom number.</p> <p>For line key type 10, param1 is the speed dial number.</p> <p>The range of the value length is 1~63 characters.</p>
Config.Programable.FWD.Param2	<p>The param2 is used to configure the account information of the programmable line key X ("X" ranges from 1-3).</p> <p>0:Auto, 1:Account 1, 2:Account 2, 3:Account 3.</p>
Config.Programable.Book.Type	<p>Configure the type of the Programmable Book key.</p> <p>The range of Type is: 1~15.</p> <p>1:DND; 2:Menu; 3:MSG; 4:Status; 5:Book; 6:Fwd; 7:PickUp; 8:Group PickUp; 9:Intercom; 10:Speed Dial; 11:History; 12:Favorite; 13:Redial; 14:Call Return;15:Hot Desking.</p>

<p>Config.Programable.Book.Param1</p>	<p>The param1 is used to configure the value of the programmable line key X ("X" ranges from 1-3).                  The param1 is only used for line key type (7, 8, 9, 10).                  For line key type 7, param1 is the pick up target.                  For line key type 8, param1 is the group pick up target.                  For line key type 9, param1 is the intercom number.                  For line key type 10, param1 is the speed dial number.                  The range of the value length is 1~63 characters.</p>
<p>Config.Programable.Book.Param2</p>	<p>The param2 is used to configure the account information of the programmable line key X ("X" ranges from 1-3).                  0:Auto,                  1:Account 1,                  2:Account 2,                  3:Account 3.</p>
<p>Config.Programable.Mute.Type</p>	<p>Configure the type of the Programmable Mute key.                  The range of Type is: 0~15.                  0:N/A; 1:DND; 2:Menu; 3:MSG; 4:Status; 5:Book;                  6:Fwd; 7:PickUp; 8:Group PickUp; 9:Intercom;                  10:Speed Dial; 11:History; 12:Favorite; 13:Redial;                  14:Call Return;15:Hot Desking.</p>
<p>Config.Programable.Mute.Param1</p>	<p>The param1 is used to configure the value of the programmable line key X ("X" ranges from 1-3).                  The param1 is only used for line key type (7, 8, 9, 10).                  For line key type 7, param1 is the pick up target.                  For line key type 8, param1 is the group pick up target.                  For line key type 9, param1 is the intercom number.                  For line key type 10, param1 is the speed dial number.                  The range of the value length is 1~63 characters.</p>
<p>Config.Programable.Mute.Param2</p>	<p>The param2 is used to configure the account information of the programmable line key X ("X" ranges from 1-3).                  0:Auto,                  1:Account 1,                  2:Account 2,</p>

	3:Account 3.
Config.Programable.Redial.Type	Configure the type of the Programmable Redial key. The range of Type is: 1~15. 1:DND; 2:Menu; 3:MSG; 4:Status; 5:Book; 6:Fwd; 7:PickUp; 8:Group PickUp; 9:Intercom; 10:Speed Dial; 11:History; 12:Favorite; 13:Redial; 14:Call Return;15:Hot Desking.
Config.Programable.Redial.Param1	The param1 is used to configure the value of the programmable line key X ("X" ranges from 1-3). The param1 is only used for line key type (7, 8, 9, 10). For line key type 7, param1 is the pick up target. For line key type 8, param1 is the group pick up target. For line key type 9, param1 is the intercom number. For line key type 10, param1 is the speed dial number. The range of the value length is 1~63 characters.
Config.Programable.Redial.Param2	The param2 is used to configure the account information of the programmable line key X ("X" ranges from 1-3). 0:Auto, 1:Account 1, 2:Account 2, 3:Account 3.
Config.Voice.General.VAD	Enable or Disable the phone to detect the silence, 0-Disbaled (default),1-Enabled.
Config.Voice.General.CNG	Enable or Disable the phone to generate comfortable noise, 0-Disabled, 1-Enabled.
Config.Voice.General.SideTone	Configure the side tone, the value ranges from-32768 to -3; the default value is -32768.
Config.Voice.General.EchoCanceller	Enable or Disable the phone to cancel echo, 0-Disabled, 1-Enabled (default).
Config.Voice.Jitter.Enable	Enable or Disable jitter buffer, 0-Disabled, 1-Enabled (default).
Config.Voice.Jitter.Adaptive	Configure the type of jitter buffer, 0-Fixed, 1-Adaptive (default).
Config.Voice.Jitter.Min	Configure the minimum delay(0 by default), maximum delay(300 by default) and normal delay (120 by default). The range of Type is: 0~1000(in millisecond).
Config.Voice.Jitter.Max	
Config.Voice.Jitter.Nominal	
Config.Voice.Tone.Country	Configure the type of voice tone.

Config.Voice.RTCP.Enable	Enable or Disable RTCP, 0-Disabled, 1-Enabled (default).
Config.Voice.RTCP.Interval	Configure the RTCP interval(in seconds).
Config.Voice.G726.Coding	Enable or Disable G726 coding, 0-Disabled, 1-Enabled (default).
Config.Tone.General.Ringback	Configure the tone ringback.
Config.Tone.General.Dialtone	Configure the dial tone.
Config.Tone.General.Callwait	Configure the call wait time.
Config.Firmware.Url	Configure the url of the firmware file server, support ftp/tftp/http/https protocol, the suffix of the file name must be .rom. The range of the value length is 1~255 characters. The max size of the firmware is 8M bytes.
Config.Ringtone.Url	Configure the url of the custom ringtone file server, support ftp/tftp/http/https protocol, the suffix of the file name must be .wav. The range of the value length is 1~255 characters. The max count of the ring file is 10, and the max total ring file size is 100K bytes.
Config.Contact.Url	Configure the url of the contact file server, support ftp/tftp/http/https protocol, the suffix of the file name must be .xml. The range of the value length is 1~255 characters. The max size of the contact file is 500K bytes.

## Appendix D: Sample Configuration File

This section provides the sample configuration file necessary to configure the IP phone. Any line beginning with a pound sign (#) is considered to be a comment, unless the # is contained within double quotes, and configuration will not take effect until the ; is deleted. For Boolean fields, 0 = disabled, 1 = enabled. This file contains sample configurations for the <r0000000000xx>.conf or <MAC>.conf file. The parameters included here are examples only. Not all possible parameters are shown in the sample configuration file. You can configure or comment the values as required. The settings in the <r0000000000xx>.conf file will be overridden by settings in the <MAC>.conf file.

### Sample Auto-Provision Configuration File

```
#Configure the url of the auto provisioning server;
;Config.Autoprovision.General.Url =

#Configure the username and password for the phone to be authenticated by the auto provision
server;
;Config.Autoprovision.General.Username =
;Config.Autoprovision.General.Pwd =

#Configure the auto provision mode;
#0:disable(default); 1:Power On; 2:Repeatedly; 3:Power On + Repeatedly
;Config.Autoprovision.Mode.Mode =

#Configure the schedule time for auto provision when the auto provision mode is Repeatedly or
Power On + Repeatedly;
#DayOfWeek: 0~7, 0 is for everyday, 1~7 is for monday~sunday;
#HourOfDay: 0~23;
;Config.Autoprovision.Schedule.DayOfWeek =
;Config.Autoprovision.Schedule.HourOfDay =

#Configure Aes key (16 bytes) for decrypting the common config file;
;Config.Autoprovision.AES.Key16 =

#Configure Aes key (16 bytes) for decrypting the Mac-Oriented config file;
;Config.Autoprovision.AES.Key16Mac =

#Enable or disable the PnP feature; 0:Disabled; 1:Enabled(default);
;Config.Autoprovision.Pnp.Enable = 1
```

```
#Configure the DHCP custom option;  
;Config.Autoprovision.Dhcp_Option.CustomId =
```

### **#Network Configuration**

```
#Configure the LAN port type; 0:DHCP(default); 1:PPPoE; 2:Static IP;  
;Config.Network.Lan.Type = 0
```

```
#Configure the Static IP address,mask,gateway and DNS server;  
;Config.Network.Lan.StaticIP =  
;Config.Network.Lan.SubnetMask =  
;Config.Network.Lan.DefaultGateway =  
;Config.Network.Lan.PrimaryDNS =  
;Config.Network.Lan.SecondaryDNS =
```

```
#Configure the username and password for PPPOE connection;  
;Config.Network.Pppoe.User =  
;Config.Network.Pppoe.Pwd =
```

```
#Enable or disable the LAN port VLAN; 0:Disabled(default); 1:Enabled;  
;Config.Network.Vlan.LanVlanEnable = 0
```

```
#Configure the LAN port VLAN ID, ranges from 0 to 4094, (0 by default);  
;Config.Network.Vlan.LanVid = 0
```

```
#Configure the LAN port VLAN priority, ranges from 0 to 7,(0 by default);  
;Config.Network.Vlan.LanPriority = 0
```

```
#Enable or disable the PC port VLAN; 0:Disabled(default); 1:Enabled;  
;Config.Network.Vlan.PcVlanEnable = 0
```

```
#Configure the LAN port PC ID, ranges from 0 to 4094, (0 by default);  
;Config.Network.Vlan.PcVid = 0
```

```
#Configure the LAN port PC priority, ranges from 0 to 7,(0 by default);  
;Config.Network.Vlan.PcPriority = 0
```

```
#Enable or disable the SNMP feature; 0:Disabled(default); 1:Enabled  
;Config.Network.Snmp.Enable = 0
```

```
#Configure the SNMP port  
;Config.Network.Snmp.Port =
```



#Configure the IP address of the SNMP server

;Config.Network.Snmp.TrustedAddress =

#Configure PC port type; 0:Router; 1:Bridge

;Config.Network.PC.Type =

#Configure PC router IP

;Config.Network.PC.RouterIP =

#Configure PC subnet mask

;Config.Network.PC.SubnetMask =

#Enable or disable the PC dhcp feature; 0:Disabled(default); 1:Enabled

;Config.Network.PC.EnableDhcp =

#Configure PC start IP and end IP

;Config.Network.PC.StartIP =

;Config.Network.PC.EndIP =

#Configure the max and min RTP port

;Config.Network.RtpPort.Max =

;Config.Network.RtpPort.Min =

#Configure the QOS values

;Config.Network.Qos.SignalTos =

;Config.Network.Qos.RtpTos =

#Configure the LLDP

;Config.Network.LLDP.LLDPEnable =

;Config.Network.LLDP.Interval =

#Enable or disable the VPN feature; 0:Disabled(default); 1:Enabled

;Config.Network.VPN.Enable =

### **#TR069 Configuration**

#Enable or disable the TR069 feature; 0:Disabled (default); 1:Enabled;

;Config.TR069.General.Enable = 0

#Configure the username and password for the phone to authenticate with the ACS;

;Config.TR069.ManagementServer.Username =

;Config.TR069.ManagementServer.Password =

```
#Configure the access URL of the ACS;  
;Config.TR069.ManagementServer.Url =
```

```
#Configure the username and password for the phone to authenticate the connection requests;  
;Config.TR069.ManagementServer.ConnectionRequestUsername =  
;Config.TR069.ManagementServer.connectionRequestPassword =
```

```
#Enable or disable the phone to report its configuration information to the ACS;  
;Config.TR069.ManagementServer.PeriodicInformEnable = 0
```

```
#Configure the interval(in seconds) for the phone to report its configuration information to the  
ACS;  
;Config.TR069.ManagementServer.PeriodicInformInterval =
```

### **#Account1 Configuration**

```
#Enable or disable the account, 0:Disabled(default); 1:Enabled;  
;Config.Account1.General.Enable =
```

```
#Configure the account label which will display on the LCD screen;  
;Config.Account1.General.Label =
```

```
#Configure the display name of account;  
;Config.Account1.General.DisplayName =
```

```
#Configure the register user name of account;  
;Config.Account1.General.Username =
```

```
#Configure the user and password for register authentication;  
;Config.Account1.General.AuthName =  
;Config.Account1.General.Pwd =
```

```
#Configure the SIP server address and port of account;  
;Config.Account1.Sip.Server =  
;Config.Account1.Sip.Port =
```

```
;Config.Account1.Sip.Server2 =  
;Config.Account1.Sip.Port2 =
```

```
#Configure the transport type; 0:UDP(Default); 1:TCP; 2:TLS;  
;Config.Account1.Sip.TransType = 0
```

```
#Configure the Listen Port;  
;Config.Account1.Sip.ListenPort =
```

#Enable or Disable the outbound proxy server;

;Config.Account1.OutProxy.Enable =

#Configure the IP address/domain of the outbound proxy server and the server port;

;Config.Account1.OutProxy.Server =

;Config.Account1.OutProxy.Port =

#Configure the backup outbound proxy server address and port;

;Config.Account1.OutProxy.BakServer =

;Config.Account1.OutProxy.BakPort =

#Configure the Stun feature;

;Config.Account1.Stun.Enable =

;Config.Account1.Stun.Server =

;Config.Account1.Stun.Port =

#Enable or Disable SRTP Encryption; 0:Disabled(Default); 1:Enabled;

;Config.Account1.Encryption.SRTPEncryption = 0

#Configure the NAT keep-alive and the keep-alive interval(in seconds);

;Config.Account1.NAT.UdpKeepEnable =

;Config.Account1.NAT.UdpKeepInterval =

;Config.Account1.NAT.NatTraversal =

;Config.Account1.NAT.StunServer =

;Config.Account1.NAT.StunPort =

;Config.Account1.NAT.Rport =

#Configure the blf subscribe period(1800 seconds by default);

;Config.Account1.Blf.SubscribePeriod = 1800

#Configure the blf list uri;

;Config.Account1.Blf.BlfListUri =

#Configure the voice message number;

;Config.Account1.VoiceMsg.Number =

#Enable or Disable auto answer when receiving a incoming call for accout1; 0:Disabled(Default);

1:Enabled;

;Config.Account1.Auto\_Answer.Enable = 0

#Enable or Disable subscribe the register status; 0:Disabled(Default); 1:Enabled;

;Config.Account1.Subscribe.SubscribeRegister = 0

#Configure the subscribe period of the register(in seconds), the range is 1800~65535, default is 1800;

```
;Config.Account1.Subscribe.SubscribePeriod = 1800
```

#Configure the subscribe period of the ACD(in seconds), the range is 1800~65535, default is 1800;

```
;Config.Account1.Subscribe.SubscribeACDExpire = 1800
```

#Enable or Disable subscribe the MWI status; 0:Disabled(Default); 1:Enabled;

```
;Config.Account1.Subscribe.SubscribeMWI = 0
```

#Configure the subscribe period of the MWI(in seconds), the range is 1800~65535, default is 1800;

```
;Config.Account1.Subscribe.SubscribeMWIExpire = 1800
```

#Enable or Disable 100 reliable retransmission; 0:Disabled(Default); 1:Enabled;

```
;Config.Account1.Call.Enable100Rel = 0
```

#Configure the RTP packet time; 0(Disabled), 10, 20, 30, 40, 50, 60;

```
;Config.Account1.Call.Ptime =
```

#Configure the register expire time(1800 seconds by default);

```
;Config.Account1.Reg.Timeout = 1800
```

```
;Config.Account1.Reg.Timeout2 =
```

#Configure the DTMF type; 0:Inband; 1:RFC2833(Default); 2:Info; 3:Inband + Info; 4:Info + RFC2833;

```
;Config.Account1.Dtmf.Type = 1
```

#Configure the RFC2833 payload, ranges from 96 to 225 (101 by default);

```
;Config.Account1.Dtmf.Payload = 101
```

#Configure DTMF info type when using Info; 0:Disabled(default); 1:DTMF-Relay; 2:DTMF; 3:Telephone-Event;

```
;Config.Account1.Dtmf.InfoType = 0
```

```
;Config.Account1.Dtmf.Duration =
```

```
;Config.Account1.Dtmf.Power =
```

#Configure AnonymousCall

```
;Config.Account1.Anonymous_Call.Enable =
```

```
;Config.Account1.Anonymous_Call.OnCode =
```

```
;Config.Account1.Anonymous_Call.OffCode =
```

**#Configure Reject AnonymousCall**

```
;Config.Account1.Reject_AnonymousCall.Enable =  
;Config.Account1.Reject_AnonymousCall.OnCode =  
;Config.Account1.Reject_AnonymousCall.OffCode =
```

**#Configure Music Server**

```
;Config.Account1.Music_Server.Enable =  
;Config.Account1.Music_Server.Uri =
```

```
;Config.Account1.Session.EnableTimer =  
;Config.Account1.Session.Interval =  
;Config.Account1.Session.Refreshers =
```

```
;Config.Account1.AOC.AocEnable =
```

**#Enable or Disable Audio codecs for account (X ranges from 0 to 12);**

```
;Config.Account1.AudioX.Enable =  
;Config.Account1.Audio0.Enable = 1  
;Config.Account1.Audio1.Enable = 1  
;Config.Account1.Audio2.Enable = 0  
;Config.Account1.Audio3.Enable = 0  
;Config.Account1.Audio4.Enable = 1  
;Config.Account1.Audio5.Enable = 1  
;Config.Account1.Audio6.Enable = 0  
;Config.Account1.Audio7.Enable = 0  
;Config.Account1.Audio8.Enable = 0  
;Config.Account1.Audio9.Enable = 0  
;Config.Account1.Audio10.Enable = 0  
;Config.Account1.Audio11.Enable = 0  
;Config.Account1.Audio12.Enable = 0
```

**#Account2 Configuration**

#Enable or disable the account, 0:Disabled(default); 1:Enabled;

```
;Config.Account2.General.Enable =
```

#Configure the account label which will display on the LCD screen;

```
;Config.Account2.General.Label =
```

#Configure the display name of account;

```
;Config.Account2.General.DisplayName =
```

#Configure the register user name of account;

```
;Config.Account2.General.Username =

#Configure the user and password for register authentication;
;Config.Account2.General.AuthName =
;Config.Account2.General.Pwd =

#Configure the SIP server address and port of account;
;Config.Account2.Sip.Server =
;Config.Account2.Sip.Port =

;Config.Account2.Sip.Server2 =
;Config.Account2.Sip.Port2 =

#Configure the transport type; 0:UDP(Default); 1:TCP; 2:TLS;
;Config.Account2.Sip.TransType = 0

#Configure the Listen Port;
;Config.Account2.Sip.ListenPort =

#Enable or Disable the outbound proxy server;
;Config.Account2.OutProxy.Enable =

#Configure the IP address/domain of the outbound proxy server and the server port;
;Config.Account2.OutProxy.Server =
;Config.Account2.OutProxy.Port =

#Configure the backup outbound proxy server address and port;
;Config.Account2.OutProxy.BakServer =
;Config.Account2.OutProxy.BakPort =

#Configure the Stun feature;
;Config.Account2.Stun.Enable =
;Config.Account2.Stun.Server =
;Config.Account2.Stun.Port =

#Enable or Disable SRTP Encryption; 0:Disabled(Default); 1:Enabled;
;Config.Account2.Encryption.SRTPEncryption = 0

#Configure the NAT keep-alive and the keep-alive interval(in seconds);
;Config.Account2.NAT.UdpKeepEnable =
;Config.Account2.NAT.UdpKeepInterval =
;Config.Account2.NAT.NatTraversal =
;Config.Account2.NAT.StunServer =
;Config.Account2.NAT.StunPort =
```

```
;Config.Account2.NAT.Rport =
```

```
#Configure the blf subscribe period(1800 seconds by default);
```

```
;Config.Account2.Blf.SubscribePeriod = 1800
```

```
#Configure the blf list uri;
```

```
;Config.Account2.Blf.BlfListUri =
```

```
#Configure the voice message number;
```

```
;Config.Account2.VoiceMsg.Number =
```

```
#Enable or Disable auto answer when receiving a incoming call for accout1; 0:Disabled(Default);
```

```
1:Enabled;
```

```
;Config.Account2.Auto_Answer.Enable = 0
```

```
#Enable or Disable subscribe the register status; 0:Disabled(Default); 1:Enabled;
```

```
;Config.Account2.Subscribe.SubscribeRegister = 0
```

```
#Configure the subscribe period of the register(in seconds), the range is 1800~65535, default is 1800;
```

```
;Config.Account2.Subscribe.SubscribePeriod = 1800
```

```
#Configure the subscribe period of the ACD(in seconds), the range is 1800~65535, default is 1800;
```

```
;Config.Account2.Subscribe.SubscribeACDExpire = 1800
```

```
#Enable or Disable subscribe the MWI status; 0:Disabled(Default); 1:Enabled;
```

```
;Config.Account2.Subscribe.SubscribeMWI = 0
```

```
#Configure the subscribe period of the MWI(in seconds), the range is 1800~65535, default is 1800;
```

```
;Config.Account2.Subscribe.SubscribeMWIExpire = 1800
```

```
#Enable or Disable 100 reliable retransmission; 0:Disabled(Default); 1:Enabled;
```

```
;Config.Account2.Call.Enable100Rel = 0
```

```
#Configure the RTP packet time; 0(Disabled), 10, 20, 30, 40, 50, 60;
```

```
;Config.Account2.Call.Ptime =
```

```
#Configure the register expire time(1800 seconds by default);
```

```
;Config.Account2.Reg.Timeout = 1800
```

```
;Config.Account2.Reg.Timeout2 =
```

```
#Configure the DTMF type; 0:Inband; 1:RFC2833(Default); 2:Info; 3:Inband + Info; 4:Info +
```

```
RFC2833;
;Config.Account2.Dtmf.Type = 1

#Configure the RFC2833 payload, ranges from 96 to 225 (101 by default);
;Config.Account2.Dtmf.Payload = 101

#Configure DTMF info type when using Info; 0:Disabled(default); 1:DTMF-Relay; 2:DTMF;
3:Telephone-Event;
;Config.Account2.Dtmf.InfoType = 0

;Config.Account2.Dtmf.Duration =
;Config.Account2.Dtmf.Power =

#Configure AnonymousCall
;Config.Account2.Anonymous_Call.Enable =
;Config.Account2.Anonymous_Call.OnCode =
;Config.Account2.Anonymous_Call.OffCode =

#Configure Reject AnonymousCall
;Config.Account2.Reject_AnonymousCall.Enable =
;Config.Account2.Reject_AnonymousCall.OnCode =
;Config.Account2.Reject_AnonymousCall.OffCode =

#Configure Music Server
;Config.Account2.Music_Server.Enable =
;Config.Account2.Music_Server.Uri =

;Config.Account2.Session.EnableTimer =
;Config.Account2.Session.Interval =
;Config.Account2.Session.Refreshers =

;Config.Account2.AOC.AocEnable =

#Enable or Disable Audio codecs for account (X ranges from 0 to 12);
;Config.Account2.AudioX.Enable =
;Config.Account2.Audio0.Enable = 1
;Config.Account2.Audio1.Enable = 1
;Config.Account2.Audio2.Enable = 0
;Config.Account2.Audio3.Enable = 0
;Config.Account2.Audio4.Enable = 1
;Config.Account2.Audio5.Enable = 1
;Config.Account2.Audio6.Enable = 0
;Config.Account2.Audio7.Enable = 0
;Config.Account2.Audio8.Enable = 0
```



```
;Config.Account2.Audio9.Enable = 0
;Config.Account2.Audio10.Enable = 0
;Config.Account2.Audio11.Enable = 0
;Config.Account2.Audio12.Enable = 0
```

### **#Account3 Configuration**

```
#Enable or disable the account, 0:Disabled(default); 1:Enabled;
;Config.Account3.General.Enable =
```

```
#Configure the account label which will display on the LCD screen;
;Config.Account3.General.Label =
```

```
#Configure the display name of account;
;Config.Account3.General.DisplayName =
```

```
#Configure the register user name of account;
;Config.Account3.General.Username =
```

```
#Configure the user and password for register authentication;
;Config.Account3.General.AuthName =
;Config.Account3.General.Pwd =
```

```
#Configure the SIP server address and port of account;
;Config.Account3.Sip.Server =
;Config.Account3.Sip.Port =
```

```
;Config.Account3.Sip.Server2 =
;Config.Account3.Sip.Port2 =
```

```
#Configure the transport type; 0:UDP(Default); 1:TCP; 2:TLS;
;Config.Account3.Sip.TransType = 0
```

```
#Configure the Listen Port;
;Config.Account3.Sip.ListenPort =
```

```
#Enable or Disable the outbound proxy server;
;Config.Account3.OutProxy.Enable =
```

```
#Configure the IP address/domain of the outbound proxy server and the server port;
;Config.Account3.OutProxy.Server =
;Config.Account3.OutProxy.Port =
```

#Configure the backup outbound proxy server address and port;

;Config.Account3.OutProxy.BakServer =

;Config.Account3.OutProxy.BakPort =

#Configure the Stun feature;

;Config.Account3.Stun.Enable =

;Config.Account3.Stun.Server =

;Config.Account3.Stun.Port =

#Enable or Disable SRTP Encryption; 0:Disabled(Default); 1:Enabled;

;Config.Account3.Encryption.SRTPEncryption = 0

#Configure the NAT keep-alive and the keep-alive interval(in seconds);

;Config.Account3.NAT.UdpKeepEnable =

;Config.Account3.NAT.UdpKeepInterval =

;Config.Account3.NAT.NatTraversal =

;Config.Account3.NAT.StunServer =

;Config.Account3.NAT.StunPort =

;Config.Account3.NAT.Rport =

#Configure the blf subscribe period(1800 seconds by default);

;Config.Account3.Blf.SubscribePeriod = 1800

#Configure the blf list uri;

;Config.Account3.Blf.BlfListUri =

#Configure the voice message number;

;Config.Account3.VoiceMsg.Number =

#Enable or Disable auto answer when receiving a incoming call for accout1; 0:Disabled(Default);  
1:Enabled;

;Config.Account3.Auto\_Answer.Enable = 0

#Enable or Disable subscribe the register status; 0:Disabled(Default); 1:Enabled;

;Config.Account3.Subscribe.SubscribeRegister = 0

#Configure the subscribe period of the register(in seconds), the range is 1800~65535, default is  
1800;

;Config.Account3.Subscribe.SubscribePeriod = 1800

#Configure the subscribe period of the ACD(in seconds), the range is 1800~65535, default is  
1800;

;Config.Account3.Subscribe.SubscribeACDExpire = 1800

#Enable or Disable subscribe the MWI status; 0:Disabled(Default); 1:Enabled;  
;Config.Account3.Subscribe.SubscribeMWI = 0

#Configure the subscribe period of the MWI(in seconds), the range is 1800~65535, default is 1800;  
;Config.Account3.Subscribe.SubscribeMWIExpire = 1800

#Enable or Disable 100 reliable retransmission; 0:Disabled(Default); 1:Enabled;  
;Config.Account3.Call.Enable100Rel = 0

#Configure the RTP packet time; 0(Disabled), 10, 20, 30, 40, 50, 60;  
;Config.Account3.Call.Ptime =

#Configure the register expire time(1800 seconds by default);  
;Config.Account3.Reg.Timeout = 1800  
;Config.Account3.Reg.Timeout2 =

#Configure the DTMF type; 0:Inband; 1:RFC2833(Default); 2:Info; 3:Inband + Info; 4:Info + RFC2833;  
;Config.Account3.Dtmf.Type = 1

#Configure the RFC2833 payload, ranges from 96 to 225 (101 by default);  
;Config.Account3.Dtmf.Payload = 101

#Configure DTMF info type when using Info; 0:Disabled(default); 1:DTMF-Relay; 2:DTMF;  
3:Telephone-Event;  
;Config.Account3.Dtmf.InfoType = 0

;Config.Account3.Dtmf.Duration =  
;Config.Account3.Dtmf.Power =

#Configure AnonymousCall  
;Config.Account3.Anonymous\_Call.Enable =  
;Config.Account3.Anonymous\_Call.OnCode =  
;Config.Account3.Anonymous\_Call.OffCode =

#Configure Reject AnonymousCall  
;Config.Account3.Reject\_AnonymousCall.Enable =  
;Config.Account3.Reject\_AnonymousCall.OnCode =  
;Config.Account3.Reject\_AnonymousCall.OffCode =

#Configure Music Server  
;Config.Account3.Music\_Server.Enable =  
;Config.Account3.Music\_Server.Uri =

```
;Config.Account3.Session.EnableTimer =  
;Config.Account3.Session.Interval =  
;Config.Account3.Session.Refreshers =
```

```
;Config.Account3.AOC.AocEnable =
```

```
#Enable or Disable Audio codecs for account (X ranges from 0 to 12);
```

```
;Config.Account3.AudioX.Enable =  
;Config.Account3.Audio0.Enable = 1  
;Config.Account3.Audio1.Enable = 1  
;Config.Account3.Audio2.Enable = 0  
;Config.Account3.Audio3.Enable = 0  
;Config.Account3.Audio4.Enable = 1  
;Config.Account3.Audio5.Enable = 1  
;Config.Account3.Audio6.Enable = 0  
;Config.Account3.Audio7.Enable = 0  
;Config.Account3.Audio8.Enable = 0  
;Config.Account3.Audio9.Enable = 0  
;Config.Account3.Audio10.Enable = 0  
;Config.Account3.Audio11.Enable = 0  
;Config.Account3.Audio12.Enable = 0
```

#### **#Account4 Configuration**

```
#Enable or disable the account, 0:Disabled(default); 1:Enabled;
```

```
;Config.Account4.General.Enable =
```

```
#Configure the account label which will display on the LCD screen;
```

```
;Config.Account4.General.Label =
```

```
#Configure the display name of account;
```

```
;Config.Account4.General.DisplayName =
```

```
#Configure the register user name of account;
```

```
;Config.Account4.General.Username =
```

```
#Configure the user and password for register authentication;
```

```
;Config.Account4.General.AuthName =
```

```
;Config.Account4.General.Pwd =
```

```
#Configure the SIP server address and port of account;
```

```
;Config.Account4.Sip.Server =
```

```
;Config.Account4.Sip.Port =

;Config.Account4.Sip.Server2 =
;Config.Account4.Sip.Port2 =

#Configure the transport type; 0:UDP(Default); 1:TCP; 2:TLS;
;Config.Account4.Sip.TransType = 0

#Configure the Listen Port;
;Config.Account4.Sip.ListenPort =

#Enable or Disable the outbound proxy server;
;Config.Account4.OutProxy.Enable =

#Configure the IP address/domain of the outbound proxy server and the server port;
;Config.Account4.OutProxy.Server =
;Config.Account4.OutProxy.Port =

#Configure the backup outbound proxy server address and port;
;Config.Account4.OutProxy.BakServer =
;Config.Account4.OutProxy.BakPort =

#Configure the Stun feature;
;Config.Account4.Stun.Enable =
;Config.Account4.Stun.Server =
;Config.Account4.Stun.Port =

#Enable or Disable SRTP Encryption; 0:Disabled(Default); 1:Enabled;
;Config.Account4.Encryption.SRTPEncryption = 0

#Configure the NAT keep-alive and the keep-alive interval(in seconds);
;Config.Account4.NAT.UdpKeepEnable =
;Config.Account4.NAT.UdpKeepInterval =
;Config.Account4.NAT.NatTraversal =
;Config.Account4.NAT.StunServer =
;Config.Account4.NAT.StunPort =
;Config.Account4.NAT.Rport =

#Configure the blf subscribe period(1800 seconds by default);
;Config.Account4.Blf.SubscribePeriod = 1800

#Configure the blf list uri;
;Config.Account4.Blf.BlfListUri =
```

#Configure the voice message number;  
;Config.Account4.VoiceMsg.Number =

#Enable or Disable auto answer when receiving a incoming call for accout1; 0:Disabled(Default);  
1:Enabled;  
;Config.Account4.Auto\_Answer.Enable = 0

#Enable or Disable subscribe the register status; 0:Disabled(Default); 1:Enabled;  
;Config.Account4.Subscribe.SubscribeRegister = 0

#Configure the subscribe period of the register(in seconds), the range is 1800~65535, default is  
1800;  
;Config.Account4.Subscribe.SubscribePeriod = 1800

#Configure the subscribe period of the ACD(in seconds), the range is 1800~65535, default is  
1800;  
;Config.Account4.Subscribe.SubscribeACDExpire = 1800

#Enable or Disable subscribe the MWI status; 0:Disabled(Default); 1:Enabled;  
;Config.Account4.Subscribe.SubsribeMWI = 0

#Configure the subscribe period of the MWI(in seconds), the range is 1800~65535, default is  
1800;  
;Config.Account4.Subscribe.SubscribeMWIExpire = 1800

#Enable or Disable 100 reliable retransmission; 0:Disabled(Default); 1:Enabled;  
;Config.Account4.Call.Enable100Rel = 0

#Configure the RTP packet time; 0(Disabled), 10, 20, 30, 40, 50, 60;  
;Config.Account4.Call.Ptime =

#Configure the register expire time(1800 seconds by default);  
;Config.Account4.Reg.Timeout = 1800  
;Config.Account4.Reg.Timeout2 =

#Configure the DTMF type; 0:Inband; 1:RFC2833(Default); 2:Info; 3:Inband + Info; 4:Info +  
RFC2833;  
;Config.Account4.Dtmf.Type = 1

#Configure the RFC2833 payload, ranges from 96 to 225 (101 by default);  
;Config.Account4.Dtmf.Payload = 101

#Configure DTMF info type when using Info; 0:Disabled(default); 1:DTMF-Relay; 2:DTMF;  
3:Telephone-Event;

```
;Config.Account4.Dtmf.InfoType = 0

;Config.Account4.Dtmf.Duration =
;Config.Account4.Dtmf.Power =

#Configure AnonymousCall
;Config.Account4.Anonymous_Call.Enable =
;Config.Account4.Anonymous_Call.OnCode =
;Config.Account4.Anonymous_Call.OffCode =

#Configure Reject AnonymousCall
;Config.Account4.Reject_AnonymousCall.Enable =
;Config.Account4.Reject_AnonymousCall.OnCode =
;Config.Account4.Reject_AnonymousCall.OffCode =

#Configure Music Server
;Config.Account4.Music_Server.Enable =
;Config.Account4.Music_Server.Uri =

;Config.Account4.Session.EnableTimer =
;Config.Account4.Session.Interval =
;Config.Account4.Session.Refreshers =

;Config.Account4.AOC.AocEnable =

#Enable or Disable Audio codecs for account (X ranges from 0 to 12);
;Config.Account4.AudioX.Enable =
;Config.Account4.Audio0.Enable = 1
;Config.Account4.Audio1.Enable = 1
;Config.Account4.Audio2.Enable = 0
;Config.Account4.Audio3.Enable = 0
;Config.Account4.Audio4.Enable = 1
;Config.Account4.Audio5.Enable = 1
;Config.Account4.Audio6.Enable = 0
;Config.Account4.Audio7.Enable = 0
;Config.Account4.Audio8.Enable = 0
;Config.Account4.Audio9.Enable = 0
;Config.Account4.Audio10.Enable = 0
;Config.Account4.Audio11.Enable = 0
;Config.Account4.Audio12.Enable = 0
```

**#Account5 Configuration**

#Enable or disable the account, 0:Disabled(default); 1:Enabled;

;Config.Account5.General.Enable =

#Configure the account label which will display on the LCD screen;

;Config.Account5.General.Label =

#Configure the display name of account;

;Config.Account5.General.DisplayName =

#Configure the register user name of account;

;Config.Account5.General.Username =

#Configure the user and password for register authentication;

;Config.Account5.General.AuthName =

;Config.Account5.General.Pwd =

#Configure the SIP server address and port of account;

;Config.Account5.Sip.Server =

;Config.Account5.Sip.Port =

;Config.Account5.Sip.Server2 =

;Config.Account5.Sip.Port2 =

#Configure the transport type; 0:UDP(Default); 1:TCP; 2:TLS;

;Config.Account5.Sip.TransType = 0

#Configure the Listen Port;

;Config.Account5.Sip.ListenPort =

#Enable or Disable the outbound proxy server;

;Config.Account5.OutProxy.Enable =

#Configure the IP address/domain of the outbound proxy server and the server port;

;Config.Account5.OutProxy.Server =

;Config.Account5.OutProxy.Port =

#Configure the backup outbound proxy server address and port;

;Config.Account5.OutProxy.BakServer =

;Config.Account5.OutProxy.BakPort =



```
#Configure the Stun feature;
;Config.Account5.Stun.Enable =
;Config.Account5.Stun.Server =
;Config.Account5.Stun.Port =

#Enable or Disable SRTP Encryption; 0:Disabled(Default); 1:Enabled;
;Config.Account5.Encryption.SRTPEncryption = 0

#Configure the NAT keep-alive and the keep-alive interval(in seconds);
;Config.Account5.NAT.UdpKeepEnable =
;Config.Account5.NAT.UdpKeepInterval =
;Config.Account5.NAT.NatTraversal =
;Config.Account5.NAT.StunServer =
;Config.Account5.NAT.StunPort =
;Config.Account5.NAT.Rport =

#Configure the blf subscribe period(1800 seconds by default);
;Config.Account5.Blf.SubscribePeriod = 1800

#Configure the blf list uri;
;Config.Account5.Blf.BlfListUri =

#Configure the voice message number;
;Config.Account5.VoiceMsg.Number =

#Enable or Disable auto answer when receiving a incoming call for accout1; 0:Disabled(Default);
1:Enabled;
;Config.Account5.Auto_Answer.Enable = 0

#Enable or Disable subscribe the register status; 0:Disabled(Default); 1:Enabled;
;Config.Account5.Subscribe.SubscribeRegister = 0

#Configure the subscribe period of the register(in seconds), the range is 1800~65535, default is
1800;
;Config.Account5.Subscribe.SubscribePeriod = 1800

#Configure the subscribe period of the ACD(in seconds), the range is 1800~65535, default is
1800;
;Config.Account5.Subscribe.SubscribeACDExpire = 1800

#Enable or Disable subscribe the MWI status; 0:Disabled(Default); 1:Enabled;
;Config.Account5.Subscribe.SubscribeMWI = 0
```

#Configure the subscribe period of the MWI(in seconds), the range is 1800~65535, default is 1800;

```
;Config.Account5.Subscribe.SubscribeMWIExpire = 1800
```

#Enable or Disable 100 reliable retransmission; 0:Disabled(Default); 1:Enabled;

```
;Config.Account5.Call.Enable100Rel = 0
```

#Configure the RTP packet time; 0(Disabled), 10, 20, 30, 40, 50, 60;

```
;Config.Account5.Call.Ptime =
```

#Configure the register expire time(1800 seconds by default);

```
;Config.Account5.Reg.Timeout = 1800
```

```
;Config.Account5.Reg.Timeout2 =
```

#Configure the DTMF type; 0:Inband; 1:RFC2833(Default); 2:Info; 3:Inband + Info; 4:Info + RFC2833;

```
;Config.Account5.Dtmf.Type = 1
```

#Configure the RFC2833 payload, ranges from 96 to 225 (101 by default);

```
;Config.Account5.Dtmf.Payload = 101
```

#Configure DTMF info type when using Info; 0:Disabled(default); 1:DTMF-Relay; 2:DTMF; 3:Telephone-Event;

```
;Config.Account5.Dtmf.InfoType = 0
```

```
;Config.Account5.Dtmf.Duration =
```

```
;Config.Account5.Dtmf.Power =
```

#Configure AnonymousCall

```
;Config.Account5.Anonymous_Call.Enable =
```

```
;Config.Account5.Anonymous_Call.OnCode =
```

```
;Config.Account5.Anonymous_Call.OffCode =
```

#Configure Reject AnonymousCall

```
;Config.Account5.Reject_AnonymousCall.Enable =
```

```
;Config.Account5.Reject_AnonymousCall.OnCode =
```

```
;Config.Account5.Reject_AnonymousCall.OffCode =
```

#Configure Music Server

```
;Config.Account5.Music_Server.Enable =
```

```
;Config.Account5.Music_Server.Uri =
```

```
;Config.Account5.Session.EnableTimer =
```

```
;Config.Account5.Session.Interval =
```

```
;Config.Account5.Session.Refreshers =
```

```
;Config.Account5.AOC.AocEnable =
```

```
#Enable or Disable Audio codecs for account (X ranges from 0 to 12);
```

```
;Config.Account5.AudioX.Enable =
```

```
;Config.Account5.Audio0.Enable = 1
```

```
;Config.Account5.Audio1.Enable = 1
```

```
;Config.Account5.Audio2.Enable = 0
```

```
;Config.Account5.Audio3.Enable = 0
```

```
;Config.Account5.Audio4.Enable = 1
```

```
;Config.Account5.Audio5.Enable = 1
```

```
;Config.Account5.Audio6.Enable = 0
```

```
;Config.Account5.Audio7.Enable = 0
```

```
;Config.Account5.Audio8.Enable = 0
```

```
;Config.Account5.Audio9.Enable = 0
```

```
;Config.Account5.Audio10.Enable = 0
```

```
;Config.Account5.Audio11.Enable = 0
```

```
;Config.Account5.Audio12.Enable = 0
```

### **#Account6 Configuration**

```
#Enable or disable the account, 0:Disabled(default); 1:Enabled;
```

```
;Config.Account6.General.Enable =
```

```
#Configure the account label which will display on the LCD screen;
```

```
;Config.Account6.General.Label =
```

```
#Configure the display name of account;
```

```
;Config.Account6.General.DisplayName =
```

```
#Configure the register user name of account;
```

```
;Config.Account6.General.Username =
```

```
#Configure the user and password for register authentication;
```

```
;Config.Account6.General.AuthName =
```

```
;Config.Account6.General.Pwd =
```

```
#Configure the SIP server address and port of account;
```

```
;Config.Account6.Sip.Server =
```

```
;Config.Account6.Sip.Port =
```

```
;Config.Account6.Sip.Server2 =
```

```
;Config.Account6.Sip.Port2 =
```

```
#Configure the transport type; 0:UDP(Default); 1:TCP; 2:TLS;  
;Config.Account6.Sip.TransType = 0
```

```
#Configure the Listen Port;  
;Config.Account6.Sip.ListenPort =
```

```
#Enable or Disable the outbound proxy server;  
;Config.Account6.OutProxy.Enable =
```

```
#Configure the IP address/domain of the outbound proxy server and the server port;  
;Config.Account6.OutProxy.Server =  
;Config.Account6.OutProxy.Port =
```

```
#Configure the backup outbound proxy server address and port;  
;Config.Account6.OutProxy.BakServer =  
;Config.Account6.OutProxy.BakPort =
```

```
#Configure the Stun feature;  
;Config.Account6.Stun.Enable =  
;Config.Account6.Stun.Server =  
;Config.Account6.Stun.Port =
```

```
#Enable or Disable SRTP Encryption; 0:Disabled(Default); 1:Enabled;  
;Config.Account6.Encryption.SRTPEncryption = 0
```

```
#Configure the NAT keep-alive and the keep-alive interval(in seconds);  
;Config.Account6.NAT.UdpKeepEnable =  
;Config.Account6.NAT.UdpKeepInterval =  
;Config.Account6.NAT.NatTraversal =  
;Config.Account6.NAT.StunServer =  
;Config.Account6.NAT.StunPort =  
;Config.Account6.NAT.Rport =
```

```
#Configure the blf subscribe period(1800 seconds by default);  
;Config.Account6.Blf.SubscribePeriod = 1800
```

```
#Configure the blf list uri;  
;Config.Account6.Blf.BlfListUri =
```

```
#Configure the voice message number;  
;Config.Account6.VoiceMsg.Number =
```

#Enable or Disable auto answer when receiving a incoming call for accout1; 0:Disabled(Default); 1:Enabled;

;Config.Account6.Auto\_Answer.Enable = 0

#Enable or Disable subscribe the register status; 0:Disabled(Default); 1:Enabled;

;Config.Account6.Subscribe.SubscribeRegister = 0

#Configure the subscribe period of the register(in seconds), the range is 1800~65535, default is 1800;

;Config.Account6.Subscribe.SubscribePeriod = 1800

#Configure the subscribe period of the ACD(in seconds), the range is 1800~65535, default is 1800;

;Config.Account6.Subscribe.SubscribeACDExpire = 1800

#Enable or Disable subscribe the MWI status; 0:Disabled(Default); 1:Enabled;

;Config.Account6.Subscribe.SubsribeMWI = 0

#Configure the subscribe period of the MWI(in seconds), the range is 1800~65535, default is 1800;

;Config.Account6.Subscribe.SubscribeMWIExpire = 1800

#Enable or Disable 100 reliable retransmission; 0:Disabled(Default); 1:Enabled;

;Config.Account6.Call.Enable100Rel = 0

#Configure the RTP packet time; 0(Disabled), 10, 20, 30, 40, 50, 60;

;Config.Account6.Call.Ptime =

#Configure the register expire time(1800 seconds by default);

;Config.Account6.Reg.Timeout = 1800

;Config.Account6.Reg.Timeout2 =

#Configure the DTMF type; 0:Inband; 1:RFC2833(Default); 2:Info; 3:Inband + Info; 4:Info + RFC2833;

;Config.Account6.Dtmf.Type = 1

#Configure the RFC2833 payload, ranges from 96 to 225 (101 by default);

;Config.Account6.Dtmf.Payload = 101

#Configure DTMF info type when using Info; 0:Disabled(default); 1:DTMF-Relay; 2:DTMF; 3:Telephone-Event;

;Config.Account6.Dtmf.InfoType = 0

;Config.Account6.Dtmf.Duration =

```
;Config.Account6.Dtmf.Power =
```

```
#Configure AnonymousCall
```

```
;Config.Account6.Anonymous_Call.Enable =
```

```
;Config.Account6.Anonymous_Call.OnCode =
```

```
;Config.Account6.Anonymous_Call.OffCode =
```

```
#Configure Reject AnonymousCall
```

```
;Config.Account6.Reject_AnonymousCall.Enable =
```

```
;Config.Account6.Reject_AnonymousCall.OnCode =
```

```
;Config.Account6.Reject_AnonymousCall.OffCode =
```

```
#Configure Music Server
```

```
;Config.Account6.Music_Server.Enable =
```

```
;Config.Account6.Music_Server.Uri =
```

```
;Config.Account6.Session.EnableTimer =
```

```
;Config.Account6.Session.Interval =
```

```
;Config.Account6.Session.Refreshers =
```

```
;Config.Account6.AOC.AocEnable =
```

```
#Enable or Disable Audio codecs for account (X ranges from 0 to 12);
```

```
;Config.Account6.AudioX.Enable =
```

```
;Config.Account6.Audio0.Enable = 1
```

```
;Config.Account6.Audio1.Enable = 1
```

```
;Config.Account6.Audio2.Enable = 0
```

```
;Config.Account6.Audio3.Enable = 0
```

```
;Config.Account6.Audio4.Enable = 1
```

```
;Config.Account6.Audio5.Enable = 1
```

```
;Config.Account6.Audio6.Enable = 0
```

```
;Config.Account6.Audio7.Enable = 0
```

```
;Config.Account6.Audio8.Enable = 0
```

```
;Config.Account6.Audio9.Enable = 0
```

```
;Config.Account6.Audio10.Enable = 0
```

```
;Config.Account6.Audio11.Enable = 0
```

```
;Config.Account6.Audio12.Enable = 0
```

### **#Call Forward Configuration**

```
#Enable or Disable Always Forward; 0:Disabled(Default); 1:Enabled;
```

```
;Config.Forward.Always.Enable = 0
```

#Configure target phonenumber that the phone will Always Forward to:

;Config.Forward.Always.Target =

#Configure On or off Code for Always Forward;

;Config.Forward.Always.OnCode =

;Config.Forward.Always.OffCode =

#Enable or Disable Busy Forward; 0:Disabled(Default); 1:Enabled;

;Config.Forward.Busy.Enable = 0

#Configure target phonenumber that the phone will Busy Forward to:

;Config.Forward.Busy.Target =

#Configure On or off Code for Busy Forward;

;Config.Forward.Busy.OnCode =

;Config.Forward.Busy.OffCode =

#Enable or Disable No Answer Forward; 0:Disabled(Default); 1:Enabled;

;Config.Forward.Timeout.Enable = 0

#Configure target phonenumber that the phone will No Answer Forward to:

;Config.Forward.Timeout.Target =

#Configure No answer timeout the time after which the call will be forwarded when using No Answer Forward, the range is 0~45(in seconds)

;Config.Forward.Timeout.Timeout = 30

#Configure On or off Code for No Answer Forward;

;Config.Forward.Timeout.OnCode =

;Config.Forward.Timeout.OffCode =

### **#Call Park Configuration**

#Enable or Disable Call Park; 0:Disabled(Default); 1:Enabled;

;Config.Forward.CallPark.Enable = 0

#Configure target phonenumber that the phone will Call Park to;

;Config.Forward.CallPark.Target =

#Configure line that the phone will Call Park to; the value is 0(Default), 1, 2, 3;

;Config.Forward.CallPark.Line = 0

**#BroadSoft Phone Book Configuration**

#Configuration of BroadSoft phonebook X ("X" ranges from 0-5);

#Config.BroadSoft.BroadSoftX.DisplayName =

#Config.BroadSoft.BroadSoftX.Server =

#Config.BroadSoft.BroadSoftX.Port =

#Config.BroadSoft.BroadSoftX.Username =

#Config.BroadSoft.BroadSoftX.Password =

;Config.BroadSoft.BroadSoft0.DisplayName =

;Config.BroadSoft.BroadSoft0.Server =

;Config.BroadSoft.BroadSoft0.Port =

;Config.BroadSoft.BroadSoft0.Username =

;Config.BroadSoft.BroadSoft0.Password =

;Config.BroadSoft.BroadSoft1.DisplayName =

;Config.BroadSoft.BroadSoft1.Server =

;Config.BroadSoft.BroadSoft1.Port =

;Config.BroadSoft.BroadSoft1.Username =

;Config.BroadSoft.BroadSoft1.Password =

;Config.BroadSoft.BroadSoft2.DisplayName =

;Config.BroadSoft.BroadSoft2.Server =

;Config.BroadSoft.BroadSoft2.Port =

;Config.BroadSoft.BroadSoft2.Username =

;Config.BroadSoft.BroadSoft2.Password =

;Config.BroadSoft.BroadSoft3.DisplayName =

;Config.BroadSoft.BroadSoft3.Server =

;Config.BroadSoft.BroadSoft3.Port =

;Config.BroadSoft.BroadSoft3.Username =

;Config.BroadSoft.BroadSoft3.Password =

;Config.BroadSoft.BroadSoft4.DisplayName =

;Config.BroadSoft.BroadSoft4.Server =

;Config.BroadSoft.BroadSoft4.Port =

;Config.BroadSoft.BroadSoft4.Username =

;Config.BroadSoft.BroadSoft4.Password =

;Config.BroadSoft.BroadSoft5.DisplayName =

;Config.BroadSoft.BroadSoft5.Server =



```
;Config.BroadSoft.BroadSoft5.Port =  
;Config.BroadSoft.BroadSoft5.Username =  
;Config.BroadSoft.BroadSoft5.Password =
```

### **#Remote Phone Book Configuration**

```
#Configuration of Remote phonebook X ("X" ranges from 0-4);  
#Config.RemotePhoneBook.Remote_Phone_BookX.DisplayName =  
#Config.RemotePhoneBook.Remote_Phone_BookX.Url =
```

```
;Config.RemotePhoneBook.Remote_Phone_Book0.DisplayName =  
;Config.RemotePhoneBook.Remote_Phone_Book0.Url =
```

```
;Config.RemotePhoneBook.Remote_Phone_Book1.DisplayName =  
;Config.RemotePhoneBook.Remote_Phone_Book1.Url =
```

```
;Config.RemotePhoneBook.Remote_Phone_Book2.DisplayName =  
;Config.RemotePhoneBook.Remote_Phone_Book2.Url =
```

```
;Config.RemotePhoneBook.Remote_Phone_Book3.DisplayName =  
;Config.RemotePhoneBook.Remote_Phone_Book3.Url =
```

```
;Config.RemotePhoneBook.Remote_Phone_Book4.DisplayName =  
;Config.RemotePhoneBook.Remote_Phone_Book4.Url =
```

### **#LDAP Configuration**

```
#Configure the search criteria for name and number lookups;  
;Config.Ldap.Ldap.NameFilter =  
;Config.Ldap.Ldap.NumberFilter =
```

```
#Configure the LDAP server and port;  
;Config.Ldap.Ldap.Server =  
;Config.Ldap.Ldap.Port =
```

```
#Configure the LDAP root path;  
;Config.Ldap.Ldap.Root =
```

```
#Configure the LDAP username and password;  
;Config.Ldap.Ldap.User =  
;Config.Ldap.Ldap.Pwd =
```

```
#Configure the maximum displayed search results, ranges from 1 to 32000(50 by default),the  
valid value is Integer;
```

```
;Config.Ldap.Ldap.MaxHits = 50
```

```
#Configure the search attribute for name and number lookups;
```

```
;Config.Ldap.Ldap.NameAttr =
```

```
;Config.Ldap.Ldap.NumberAttr =
```

```
;Config.Ldap.Ldap.DisplayName =
```

```
#Configure the search delay time,ranges from 0 to 2000, (in milliseconds, 0 by default);
```

```
;Config.Ldap.Ldap.SearchDelay = 0
```

### **#Area Code Configuration**

```
#Configure the area code;
```

```
;Config.AreaCode.General.Code =
```

```
;Config.AreaCode.General.MaxLen =
```

```
;Config.AreaCode.General.MinLen =
```

```
#Configure the line of area code; the valid value is: 0(default), 1, 2, 3; 0 is for auto;
```

```
;Config.AreaCode.General.Account = 0
```

### **#Phone Features Configuration**

```
#Enable or disable the call waiting feature; 0:Disabled; 1:Enabled(default);
```

```
;Config.Features.Call_Waiting.Enable = 1
```

```
#Configure the phone to play warning tone when receiving an incoming call during an active call;
```

```
0:Disabled; 1:Enabled(default);
```

```
;Config.Features.Call_Waiting.PlayTone = 1
```

```
#Enable or disable the hotline feature; 0:Disabled(default); 1:Enabled;
```

```
;Config.Features.Hotline.Enable = 0
```

```
#Configure the hotline number and delay time;
```

```
;Config.Features.Hotline.Number =
```

```
;Config.Features.Hotline.Delay = 4
```

```
#Enable or disable the DND feature; 0:Disabled(default); 1:Enabled;
```

```
;Config.Features.DND.Enable = 0
```

```
#Configure On or off Code for DND;
```

```
;Config.Features.DND.OnCode =
```

```
;Config.Features.DND.OffCode =
```

```
#Configure return code for DND; the valid value is: 404(Not Found); 480(Temporarily Unavailable);  
486(Busy Here);  
;Config.Features.DND.ReturnCode = 486
```

```
#Configure return code for Reject; the valid value is: 404(Not Found); 480(Temporarily  
Unavailable); 486(Busy Here);  
;Config.Features.Reject.ReturnCode = 486
```

```
#Enable or disable the intercom feature; 0-Disabled, 1-Enabled(default);  
;Config.Features.Intercom.Enable = 1
```

```
#Enable or disable the phone to mute the speaker when automatically answer an intercom call,  
0-Disabled(default), 1-Enabled;  
;Config.Features.Intercom.Mute = 0
```

```
#Configure the delay time of the dialnow feature(in seconds);  
;Config.Features.DialNow.Delay = 1
```

```
#Configure the delay time of the auto answer feature(in seconds);  
;Config.Features.AutoAnswer.Delay = 0
```

```
#Enable or disable the ACD Auto Available feature; 0-Disabled(default), 1-Enabled;  
;Config.Features.ACD.ACDAutoAvailable = 0
```

```
#Configure the time of the ACD Auto Available feature(in seconds);  
;Config.Features.ACD.ACDAutoAvailableTime = 30
```

### **#Speed Dial Configuration**

```
;Config.Features.SpeedDial.Label01 =  
;Config.Features.SpeedDial.Num01 =  
;Config.Features.SpeedDial.Line01 =
```

```
;Config.Features.SpeedDial.Label02 =  
;Config.Features.SpeedDial.Num02 =  
;Config.Features.SpeedDial.Line02 =
```

```
;Config.Features.SpeedDial.Label03 =  
;Config.Features.SpeedDial.Num03 =  
;Config.Features.SpeedDial.Line03 =
```

```
;Config.Features.SpeedDial.Label04 =
```

```
;Config.Features.SpeedDial.Num04 =
```

```
;Config.Features.SpeedDial.Line04 =
```

```
;Config.Features.SpeedDial.Label05 =
```

```
;Config.Features.SpeedDial.Num05 =
```

```
;Config.Features.SpeedDial.Line05 =
```

```
;Config.Features.SpeedDial.Label06 =
```

```
;Config.Features.SpeedDial.Num06 =
```

```
;Config.Features.SpeedDial.Line06 =
```

```
;Config.Features.SpeedDial.Label07 =
```

```
;Config.Features.SpeedDial.Num07 =
```

```
;Config.Features.SpeedDial.Line07 =
```

```
;Config.Features.SpeedDial.Label08 =
```

```
;Config.Features.SpeedDial.Num08 =
```

```
;Config.Features.SpeedDial.Line08 =
```

```
;Config.Features.SpeedDial.Label09 =
```

```
;Config.Features.SpeedDial.Num09 =
```

```
;Config.Features.SpeedDial.Line09 =
```

```
;Config.Features.SpeedDial.Label10 =
```

```
;Config.Features.SpeedDial.Num10 =
```

```
;Config.Features.SpeedDial.Line10 =
```

```
;Config.Features.SpeedDial.Label11 =
```

```
;Config.Features.SpeedDial.Num11 =
```

```
;Config.Features.SpeedDial.Line11 =
```

```
;Config.Features.SpeedDial.Label12 =
```

```
;Config.Features.SpeedDial.Num12 =
```

```
;Config.Features.SpeedDial.Line12 =
```

### **#Phone Action Url Configuration**

```
;Config.Features.ActionUrl.SetupCompleted =
```

```
;Config.Features.ActionUrl.Registered =
```

```
;Config.Features.ActionUrl.Unregistered =
```

```
;Config.Features.ActionUrl.RegisterFailed =
```

```
;Config.Features.ActionUrl.OffHook =
```

```
;Config.Features.ActionUrl.OnHook =
```

```
;Config.Features.ActionUrl.IncomingCall =
;Config.Features.ActionUrl.OutgoingCall =
;Config.Features.ActionUrl.Established =
;Config.Features.ActionUrl.Terminated =
;Config.Features.ActionUrl.OpenDND =
;Config.Features.ActionUrl.CloseDND =
;Config.Features.ActionUrl.OpenAlwaysForward =
;Config.Features.ActionUrl.CloseAlwaysForward =
;Config.Features.ActionUrl.OpenBusyForward =
;Config.Features.ActionUrl.CloseBusyForward =
;Config.Features.ActionUrl.OpenNoAnswerForward =
;Config.Features.ActionUrl.CloseNoAnswerForward =
;Config.Features.ActionUrl.TransferCall =
;Config.Features.ActionUrl.BlindTransfer =
;Config.Features.ActionUrl.AttendedTransfer =
;Config.Features.ActionUrl.Hold =
;Config.Features.ActionUrl.UnHold =
;Config.Features.ActionUrl.Mute =
;Config.Features.ActionUrl.UnMute =
;Config.Features.ActionUrl.MissedCall =
;Config.Features.ActionUrl.IPChanged =
;Config.Features.ActionUrl.ForwardInComingCall =
;Config.Features.ActionUrl.RejectInComingCall =
;Config.Features.ActionUrl.AnswerNewInCall =
;Config.Features.ActionUrl.TransferFinished =
;Config.Features.ActionUrl.TransferFailed =
;Config.Features.ActionUrl.IdleToBusy =
;Config.Features.ActionUrl.BusyToIdle =
;Config.Features.ActionUrl.Enable =
;Config.Features.RemoteControl.ActionURIAllowIPList =
```

### #Phone Settings Configuration

```
;Config.Settings.General.DirectIP =

;Config.Settings.DateDisplay.DisplayMode =
```

#Configure the language displays on the phone LCD screen, the available values are:  
0-English(default), 1-Chinese\_s;  
;Config.Settings.Language.Type = 0

#Configure the language displays on the web page, the available values are: 0-English(default),  
1-Chinese\_s;

```
;Config.Settings.Language.WebLang = 0
```

```
#Enable or disable the NTP feature; 0:Disabled; 1:Enabled(default);
```

```
;Config.Settings.SNTP.Enable = 1
```

```
#Configure the time zone and time zone name for the phone; time zone ranges from -11 to +12  
(0 by default); time zone name (GMT by default);
```

```
;Config.Settings.SNTP.TimeZone = 0
```

```
;Config.Settings.SNTP.Name = GMT
```

```
#Configure the primary and secondary NTP servers. Default-0.pool.ntp.org.
```

```
#The value can be the domain name or IP address of the NTP server.
```

```
;Config.Settings.SNTP.NTPServer1 = 0.pool.ntp.org
```

```
;Config.Settings.SNTP.NTPServer2 = 1.pool.ntp.org
```

```
#Configure the update interval(in seconds) when using NTP Server(3600 by default);
```

```
;Config.Settings.SNTP.Interval = 3600
```

```
#Configure the daylight saving time feature. 0-Disabled, 1-Enabled, 2-Automatic(default);
```

```
;Config.Settings.SNTP.DTS = 2
```

```
#Configure the DST type when the DST was set to Enabled. 0-Date, 1-Week;
```

```
;Config.Settings.DateTime.Type = 0
```

```
#Configure the start time of DST.(1/1/0 by default)
```

```
#If the DST type is set to By Date,the value format is Month/Day/Hour;
```

```
#If the DST type is set to By Week, the value format is Start Month/Start Day of Week/Start Day  
of Week Last in Month/Start Hour of Day.
```

```
#For example,the value is 1/4/2/5, it means the start time is at 5 o'clock on Tuesday, the 4th  
week in January;
```

```
;Config.Settings.SNTP.StartTime = 1/1/0
```

```
#Configure the end time of DST, (12/31/23 by default), the value format is the same as the start  
time;
```

```
;Config.Settings.SNTP.EndTime = 12/31/23
```

```
#Configure the offset time (in minutes), ranges from -300 to 300,(60 by default) the valid value is  
Integer;
```

```
;Config.Settings.DateTime.Offset = 60
```

```
#Configure the time format, 0-12 Hour, 1-24 Hour(default);
```

```
;Config.Settings.DateTime.TimeFormat = 1
```

```
#Configure the date format,
```

```
0:YYYY-MM-DD(default),1:YYYY/MM/DD,2:DD-MM-YYYY,3:DD/MM/YYYY;  
;Config.Settings.DateTime.DateFormat = 0
```

```
#Configure the backlight level, Integer,0, 1, 2, 3, 4(default), 5;  
;Config.Settings.Backlight.Level = 4
```

```
#Configure the backlight time, 0-Always off, 1-Always on, 10, 20(default), 30, 40, 50, 60, 90,  
120(in seconds);  
;Config.Settings.Backlight.Time = 20
```

```
#Configure the log level, Integer,0, 1, 2, 3(default), 4, 5, 6, 7;  
;Config.Settings.LogLevel.Level = 3
```

```
#Configure the ring tone type, string(Ring1.wav by default);  
;Config.Settings.RingTone.Type = Ring1.wav
```

```
#Configure the keyboard volume, the range is 1~15, default is 8;  
;Config.Settings.Audio.KeyVol = 8
```

```
#Configure the ring volume, the range is 1~15, default is 8;  
;Config.Settings.Audio.RingVol = 8
```

```
#Configure the hand free volume, the range is 1~15, default is 8;  
;Config.Settings.HandFree.SpKVol = 8  
;Config.Settings.HandFree.MicVol = 8  
;Config.Settings.HandFree.SigToneVol = 8
```

```
#Configure the hand set volume, the range is 1~15, default is 8;  
;Config.Settings.HandSet.SpKVol = 8  
;Config.Settings.HandSet.MicVol = 8  
;Config.Settings.HandSet.SigToneVol = 8
```

```
#Configure the head set volume, the range is 1~15, default is 8;  
;Config.Settings.HeadSet.SpKVol = 8  
;Config.Settings.HeadSet.MicVol = 8  
;Config.Settings.HeadSet.SigToneVol = 8
```

```
#Configure the login password of the advanced settings on the phone UI(admin by default);  
;Config.Settings.Login.Password = admin
```

```
#Configure the login password of the web(admin by default);  
;Config.Settings.Web_Login.Password = admin
```

```
#Configure the timeout of the dial in or dial out(in seconds, 60 by default);
```

```
;Config.Settings.CallTimeOut.DialIn = 60
;Config.Settings.CallTimeOut.DialOut = 60
```

```
#Configure the distinctive ring;
```

```
;Config.Settings.Ringer.Keyword01 =
;Config.Settings.Ringer.Ringtone01 =
```

```
;Config.Settings.Ringer.Keyword02 =
;Config.Settings.Ringer.Ringtone02 =
```

```
;Config.Settings.Ringer.Keyword03 =
;Config.Settings.Ringer.Ringtone03 =
```

```
;Config.Settings.Ringer.Keyword04 =
;Config.Settings.Ringer.Ringtone04 =
```

```
;Config.Settings.Ringer.Keyword05 =
;Config.Settings.Ringer.Ringtone05 =
```

```
;Config.Settings.Ringer.Keyword06 =
;Config.Settings.Ringer.Ringtone06 =
```

```
;Config.Settings.Ringer.Keyword07 =
;Config.Settings.Ringer.Ringtone07 =
```

```
;Config.Settings.Ringer.Keyword08 =
;Config.Settings.Ringer.Ringtone08 =
```

```
;Config.Settings.Ringer.Keyword09 =
;Config.Settings.Ringer.Ringtone09 =
```

```
;Config.Settings.Ringer.Keyword10 =
;Config.Settings.Ringer.Ringtone10 =
```

### **#Hot Desking Configuration**

```
;Config.Settings.HotDesking.ServerName =
;Config.Settings.HotDesking.ServerPort =
;Config.Settings.HotDesking.OutBoundName =
;Config.Settings.HotDesking.OutBoundPort =
;Config.Settings.HotDesking.PhoneName =
;Config.Settings.HotDesking.RegisterName =
;Config.Settings.HotDesking.PassWord =
```



```
;Config.Settings.HotDesking.ServerName2 =  
;Config.Settings.HotDesking.ServerPort2 =
```

### **#Programmable Key Configuration**

```
;Config.Programable.LineKey1.Type =  
;Config.Programable.LineKey1.Label =  
;Config.Programable.LineKey1.Param1 =  
;Config.Programable.LineKey1.Param2 =  
;Config.Programable.LineKey1.Param3 =
```

```
;Config.Programable.LineKey2.Type =  
;Config.Programable.LineKey2.Label =  
;Config.Programable.LineKey2.Param1 =  
;Config.Programable.LineKey2.Param2 =  
;Config.Programable.LineKey2.Param3 =
```

```
;Config.Programable.LineKey3.Type =  
;Config.Programable.LineKey3.Label =  
;Config.Programable.LineKey3.Param1 =  
;Config.Programable.LineKey3.Param2 =  
;Config.Programable.LineKey3.Param3 =
```

```
;Config.Programable.LineKey4.Type =  
;Config.Programable.LineKey4.Label =  
;Config.Programable.LineKey4.Param1 =  
;Config.Programable.LineKey4.Param2 =  
;Config.Programable.LineKey4.Param3 =
```

```
;Config.Programable.LineKey5.Type =  
;Config.Programable.LineKey5.Label =  
;Config.Programable.LineKey5.Param1 =  
;Config.Programable.LineKey5.Param2 =  
;Config.Programable.LineKey5.Param3 =
```

```
;Config.Programable.LineKey6.Type =  
;Config.Programable.LineKey6.Label =  
;Config.Programable.LineKey6.Param1 =  
;Config.Programable.LineKey6.Param2 =  
;Config.Programable.LineKey6.Param3 =
```

```
;Config.Programable.LineKey7.Type =  
;Config.Programable.LineKey7.Label =
```

```
;Config.Programable.LineKey7.Param1 =  
;Config.Programable.LineKey7.Param2 =  
;Config.Programable.LineKey7.Param3 =
```

```
;Config.Programable.SoftKey01.Type =  
;Config.Programable.SoftKey01.Label =  
;Config.Programable.SoftKey01.Param1 =  
;Config.Programable.SoftKey01.Param2 =
```

```
;Config.Programable.SoftKey02.Type =  
;Config.Programable.SoftKey02.Label =  
;Config.Programable.SoftKey02.Param1 =  
;Config.Programable.SoftKey02.Param2 =
```

```
;Config.Programable.SoftKey03.Type =  
;Config.Programable.SoftKey03.Label =  
;Config.Programable.SoftKey03.Param1 =  
;Config.Programable.SoftKey03.Param2 =
```

```
;Config.Programable.SoftKey04.Type =  
;Config.Programable.SoftKey04.Label =  
;Config.Programable.SoftKey04.Param1 =  
;Config.Programable.SoftKey04.Param2 =
```

```
;Config.Programable.OK.Type =  
;Config.Programable.OK.Param1 =  
;Config.Programable.OK.Param2 =
```

```
;Config.Programable.Cancel.Type =  
;Config.Programable.Cancel.Param1 =  
;Config.Programable.Cancel.Param2 =  
;
```

```
;Config.Programable.FWD.Type =  
;Config.Programable.FWD.Param1 =  
;Config.Programable.FWD.Param2 =
```

```
;Config.Programable.Book.Type =  
;Config.Programable.Book.Param1 =  
;Config.Programable.Book.Param2 =
```

```
;Config.Programable.Mute.Type =  
;Config.Programable.Mute.Param1 =  
;Config.Programable.Mute.Param2 =
```

```
;Config.Programable.Redial.Type =
;Config.Programable.Redial.Param1 =
;Config.Programable.Redial.Param2 =

;Config.Programable.DssKey01.Type =
;Config.Programable.DssKey01.Param1 =
;Config.Programable.DssKey01.Param2 =
;Config.Programable.DssKey01.Param3 =

;Config.Programable.DssKey02.Type =
;Config.Programable.DssKey02.Param1 =
;Config.Programable.DssKey02.Param2 =
;Config.Programable.DssKey02.Param3 =

;Config.Programable.DssKey03.Type =
;Config.Programable.DssKey03.Param1 =
;Config.Programable.DssKey03.Param2 =
;Config.Programable.DssKey03.Param3 =

;Config.Programable.DssKey04.Type =
;Config.Programable.DssKey04.Param1 =
;Config.Programable.DssKey04.Param2 =
;Config.Programable.DssKey04.Param3 =

;Config.Programable.DssKey05.Type =
;Config.Programable.DssKey05.Param1 =
;Config.Programable.DssKey05.Param2 =
;Config.Programable.DssKey05.Param3 =

;Config.Programable.DssKey06.Type =
;Config.Programable.DssKey06.Param1 =
;Config.Programable.DssKey06.Param2 =
;Config.Programable.DssKey06.Param3 =

;Config.Programable.DssKey07.Type =
;Config.Programable.DssKey07.Param1 =
;Config.Programable.DssKey07.Param2 =
;Config.Programable.DssKey07.Param3 =

;Config.Programable.DssKey08.Type =
;Config.Programable.DssKey08.Param1 =
;Config.Programable.DssKey08.Param2 =
;Config.Programable.DssKey08.Param3 =
```

```
;Config.Programable.DssKey09.Type =  
;Config.Programable.DssKey09.Param1 =  
;Config.Programable.DssKey09.Param2 =  
;Config.Programable.DssKey09.Param3 =
```

```
;Config.Programable.DssKey10.Type =  
;Config.Programable.DssKey10.Param1 =  
;Config.Programable.DssKey10.Param2 =  
;Config.Programable.DssKey10.Param3 =
```

### #Voice Configuration

```
#Enable or disable the phone to detect the silence, 0-Disbaled (default),1-Enabled;  
;Config.Voice.General.VAD = 0
```

```
#Enable or disable the phone to generate comfortable noise, 0-Disabled, 1-Enabled;  
;Config.Voice.General.CNG = 1
```

```
#Configure the side tone,the value ranges from-32768 to -3; the default value is -32768;  
;Config.Voice.General.SideTone = -32768
```

```
#Enable or disable the phone to cancel echo, 0-Disabled, 1-Enabled (default);  
;Config.Voice.General.EchoCanceller = 1
```

```
#Enable or disable jitter buffer, 0-Disabled, 1-Enabled (default);  
;Config.Voice.Jitter.Enable = 1
```

```
#Configure the type of jitter buffer, 0-Fixed, 1-Adaptive (default);  
;Config.Voice.Jitter.Adaptive = 1
```

```
#Configure the minimum delay(0 by default), maximum delay(300 by default) and normal delay  
(120 by default);  
;Config.Voice.Jitter.Min = 0  
;Config.Voice.Jitter.Max = 300  
;Config.Voice.Jitter.Nominal = 120
```

```
#Configure the type of voice tone; 0:Custom; 1:Default; 2:China; 3:Spain; 4:Luxembourg;  
5:Sweden; 6:Taiwan; 7:Belgium; 8:Denmark; 9:Finland; 10:Germany; 11:Netherlands; 12:Norways;  
13:Protugal;  
;Config.Voice.Tone.Country = 1
```

```
;Config.Voice.RTCP.Enable =  
;Config.Voice.RTCP.Interval =
```

```
;Config.Voice.G726.Coding =
```

```
#Configure the ringback tone,dial tone and call wait tone when the tone type is 0(Custom);
```

```
;Config.Tone.General.Ringback =
```

```
;Config.Tone.General.Dialtone =
```

```
;Config.Tone.General.Callwait =
```

### **#Firmware Update Configuration**

```
#Configure the url of the firmware file server, support ftp/tftp/http/https protocol, the suffix of the file name must be .rom;
```

```
;Config.Firmware.Url =
```

### **#Custom Ringtone Update Configuration**

```
#Configure the url of the custom ringtone file server, support ftp/tftp/http/https protocol, the suffix of the file name must be .wav;
```

```
;Config.Ringtone.Url =
```

### **#Contact Update Configuration**

```
#Configure the url of the contact file server, support ftp/tftp/http/https protocol, the suffix of the file name must be .xml;
```

```
;Config.Contact.Url =
```